

**NYTRO**

*performance first*

2025 CATALOGUE

EU





Photography credit: Thanks to Tom Scholey, Simon Roff, Izabela Szwed, Arnout Terlouw, Fred Lorient, Daniel Bender, Nicolas Bérout and Maciej Bartkowiak for photography work throughout this catalogue.

**EMM**  
CATCH MORE MEDIA

**AnglingTimes**



#### WHAT'S INSIDE

---

|               |   |
|---------------|---|
| NYTRO INTRO   | 4 |
| MEET THE TEAM | 5 |

---

|                                 |         |
|---------------------------------|---------|
| RODS                            | 6-26    |
| POLES                           | 27-29   |
| REELS                           | 30-41   |
| LINE                            | 42-45   |
| NETS                            | 46-48   |
| LANDING NETS                    | 49-53   |
| LANDING NET HANDLES             | 54-56   |
| BROLLIES                        | 57-59   |
| SEATBOXES, CHAIRS & ACCESSORIES | 60-70   |
| STARKX EVA-ULTRA LUGGAGE        | 71-77   |
| SUBLIME 600D LUGGAGE            | 78-85   |
| ACCESSORIES                     | 86-110  |
| CLOTHING                        | 111-116 |
| POS                             | 117     |
| SPARES                          | 118-123 |

[WWW.NYTROFISHING.COM](http://WWW.NYTROFISHING.COM)

TEL: +44 (0) 1670 798 910

EMAIL: [sales@nytrofishing.com](mailto:sales@nytrofishing.com)

Follow us on Social Media





Hello and welcome, we are proud to present our new NYTRO CATALOGUE for 2025, packed with innovative 'performance first' products! Over the last 12 months our development team, together with our key team members, have been extremely busy developing lots of new and innovative products, that we are sure you will enjoy using out on the bank.

We have expanded our best-selling Aryzon and Marvelist ranges of rods, adding in some more powerful feeder versions. We have also developed a tight range of classic float rods which have been included in the Marvelist range. In the StarkX range, we have designed a couple of 'specialist' rods for barbel fishing and under the Aryzon sub brand, we have included a new rod, reel and braid range, specifically for baiting up!

For the first time you will also find a small range of telescopic whips and take-apart margin poles up to 6m in length and in the most popular price brackets! Watch this space... there is more in the pipeline!

Besides rods, reels and poles we have also been busy with further developments including fluorocarbon power rig line and a whole range of 'Connect-It' products to complement the success of the top selling SLS36 Seat Box.

We continue to grow and build on the success that Nytro offers and we have also developed more accessories in the 'Targetz', 'Steady Rest' and 'Connex' (terminal tackle items), ranges, plus our brand new TCS Targetz Change System Flat Method Feeders and Moulds.

### **WE CONTINUE TO GROW**

At Nytro, we aim to be the first-choice brand for consumers by offering the best value-for-money, forward-thinking and cutting-edge products. Our growth over the past couple of years is a testament to this commitment. This growth continues into 2025 with many new and innovative Nytro products.

We will keep driving innovation and new product development with a focus on delivering total consumer satisfaction. When it comes to price, aesthetics and performance, you and the consumer can be confident that Nytro products offer the best value for money.

We will also continue to grow our presence on social media and in traditional printed media, to keep anglers informed about our new products. We are constantly expanding our team of anglers to maximize the brand's exposure on social media and where it matters most – out on the bank.

From our UK head office and warehouses in both the UK and the Czech Republic, our product design team, customer service, sales teams, marketing, and management, we wish you and your business all the very best for the coming year.

Enjoy the 2025 NYTRO catalogue and thank you for your trust and continued support.

Team Nytro

## DIRECTORS



**CEO**  
**Atle Håkonsen**  
atle.haakonsen@soniksports.com



**COMMERCIAL DIRECTOR**  
**Ian McCormack**  
ian.mccormack@soniksports.com



**FINANCIAL DIRECTOR**  
**David Gilthorpe**  
david.gilthorpe@soniksports.com



**EU MANAGING DIRECTOR**  
**Pascal Vermeulen**  
pascal.vermeulen@soniksports.com

## UK HEAD OFFICE



**GROUP MARKETING MANAGER**  
**Martin Ford**  
martin.ford@soniksports.com



**SENIOR COMMERCIAL ADMINISTRATOR**  
**Tracey Handyside**  
tracey.handyside@soniksports.com



**COMMERCIAL ADMINISTRATOR**  
**Lynne Kirkman**  
lynne.kirkman@soniksports.com



**CUSTOMER SERVICE MANAGER**  
**Jackie Bruce**  
jackie.bruce@soniksports.com

## COUNTRY SALES MANAGERS



 **UK MIDLANDS & SOUTH / WEST SALES MANAGER**  
**Nick Young**  
nick.young@soniksports.com

+44 (0) 7534 167 305



 **UK SOUTH / EAST SALES MANAGER**  
**Dean Rothery**  
dean.rothery@soniksports.com

+44 (0) 7805 955 805



 **UK NORTH SALES MANAGER**  
**Mark Warren**  
mark.warren@soniksports.com

+44 (0) 07983 712 446



 **BENELUX SALES MANAGER**  
**Sander Schipper**  
sander.schipper@soniksports.com

+31 (0) 614 054 622



 **BELGIUM SALES MANAGER**  
**Jan Verbruggen**  
jan.verbruggen@soniksports.com

+32 (0) 499 252 828



 **GERMANY SALES MANAGER**  
**Ronny Luft**  
ronny.luft@soniksports.com

+49 (0) 174 1906 116



 **AUSTRIA SALES MANAGER**  
**Pascal Schlüsselberger**  
pascal.schlüsselberger@soniksports.com

+43 (0) 664 411 5514



 **FRANCE SALES MANAGER**  
**Sebastien Rat**  
sebastien.rat@soniksports.com

+33 (0) 645 552 033



 **FRANCE NORTH / EAST SALES MANAGER**  
**Philemon Protoy**  
philemon.protoy@soniksports.com

+33 (0) 6 01 09 92 87



 **POLAND SALES MANAGER**  
**Bartłomiej Król**  
bartek.krol@soniksports.com

+48 (0) 786 323 237



 **ITALY SALES MANAGER**  
**Leonardo Ghisoni**  
leonardo.ghisoni@soniksports.com

+39 (0) 334 191 7570



 **SPAIN SALES MANAGER**  
**Marlene Jessen**  
marlene.jessen@soniksports.com

+34 (0) 622 522 865

ROODS



# NTR

- > Through action carbon-curve composite blanks
- > High quality black anodized line guides
- > Hook keeper
- > Feeder rods feature two carbon quiver tips (1oz and 2oz)
- > Split cork and EVA handles
- > Black varnished blank with tone-in-tone black guide wrapping
- > Screw-down reel seat
- > Supplied in a rod bag
- > Butt caps feature epoxy Nytro logo

## NTR COMMERCIAL SERIES

**CRBN CARBON-CURVE**     **Ø2.5MM TIPS**

This entry-level range of carbon crafted rods are designed with the commercial water angler in mind. Great rods for those just entering the commercial scene and at a very affordable price. Their action is powerful enough to tame small to medium sized carp and they offer a perfect combination and balance, when used in conjunction with the NTR reels.

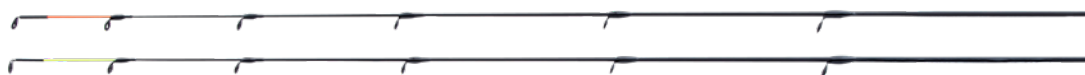

| CODE     | TREF  | DESCRIPTION                   | LENGTH      | TR. LENGTH | SECT. | TIPS    | C/WEIGHT | LINE RATING     | SU | CTN QTY | RRP    |
|----------|-------|-------------------------------|-------------|------------|-------|---------|----------|-----------------|----|---------|--------|
| 20200003 | T2219 | 9' COMMERCIAL CARP FEEDER     | 9' (2.70M)  | 141CM      | 2+2   | 1 & 2OZ | 30G      | 3-6LB/1.3-2.7KG | 1  | 25      | €39.95 |
| 20200004 | T2497 | 10' COMMERCIAL CARP FEEDER    | 10' (3.00M) | 157CM      | 2+2   | 1 & 2OZ | 40G      | 4-8LB/1.8-3.6KG | 1  | 25      | €44.95 |
| 20200005 | T2775 | 11' COMMERCIAL CARP FEEDER    | 11' (3.30M) | 173CM      | 2+2   | 1 & 2OZ | 50G      | 4-8LB/1.8-3.6KG | 1  | 25      | €49.95 |
| 20200001 | T997  | TIP 1OZ (Ø2.5MM) ORANGE       | *           | *          | *     | 1OZ     | *        | *               | 1  | *       | €17.95 |
| 20200002 | T997  | TIP 2OZ (Ø2.5MM) YELLOW       | *           | *          | *     | 2OZ     | *        | *               | 1  | *       | €17.95 |
| 20200006 | T2497 | 10' COMMERCIAL PELLET WAGGLER | 10' (3.00M) | 157CM      | 2     |         | 4-10G    | 4-8LB/1.8-3.6KG | 1  | 25      | €44.95 |
| 20200007 | T2775 | 11' COMMERCIAL PELLET WAGGLER | 11' (3.30M) | 172CM      | 2     |         | 4-10G    | 4-8LB/1.8-3.6KG | 1  | 25      | €49.95 |



RODS

NYTRO



RODS

# IMPAX

- › Progressive through action 24T carbon-curve blanks
- › Gunsmoke anodized quality line guides
- › Hook keeper
- › All feeder rods feature two carbon quiver tips (1oz and 2oz)
- › Handles combine cork and EVA grips
- › Half-matt black finish with epoxy varnished black guide wrapping
- › Screw-down reel seat
- › Supplied in a rod bag
- › Butt caps feature epoxy NyTRO logo

## IMPAX COMMERCIAL SERIES

**CRBN CARBON-CURVE**  **Ø2.5MM TIPS**

The Impax Commercial rods fall into a popular-price category, offering great value for money. It is amazing to see what our designers have been able to achieve, creating a series of rods that can handle Fl's and big carp alike. These rods have been used, abused and tested to the limit on a wide range of commercial waters, ensuring they withstand what is expected of them. They feature a splendid through-action blank, which offers sufficient backbone to boss and direct hard fighting fish straight into the net!

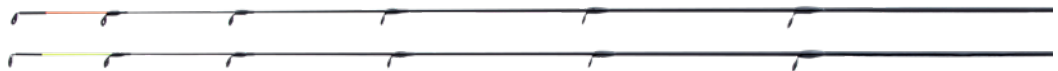

| CODE     | TREF  | DESCRIPTION                   | LENGTH      | TR. LENGTH | SECT. | TIPS    | C/WEIGHT | LINE RATING      | SU | CTN QTY | RRP    |
|----------|-------|-------------------------------|-------------|------------|-------|---------|----------|------------------|----|---------|--------|
| 20200010 | T2775 | 9' COMMERCIAL CARP FEEDER     | 9' (2.70M)  | 141CM      | 2+2   | 1 & 2OZ | 30G      | 4-8LB/1.8-3.6KG  | 1  | 25      | €49.95 |
| 20200011 | T3053 | 10' COMMERCIAL CARP FEEDER    | 10' (3.00M) | 156CM      | 2+2   | 1 & 2OZ | 40G      | 4-10LB/1.8-4.5KG | 1  | 25      | €54.95 |
| 20200012 | T3331 | 11' COMMERCIAL CARP FEEDER    | 11' (3.30M) | 175CM      | 2+2   | 1 & 2OZ | 50G      | 4-10LB/1.8-4.5KG | 1  | 25      | €59.95 |
| 20200001 | T997  | TIP 1OZ (Ø2.5MM) ORANGE       | *           | *          | *     | 1OZ     | *        | *                | 1  | 50      | €17.95 |
| 20200002 | T997  | TIP 2OZ (Ø2.5MM) YELLOW       | *           | *          | *     | 2OZ     | *        | *                | 1  | 50      | €17.95 |
| 20200008 | T3053 | 10' COMMERCIAL PELLET WAGGLER | 10' (3.00M) | 155CM      | 2     | *       | 4-10G    | 4-10LB/1.8-4.5KG | 1  | 25      | €54.95 |
| 20200009 | T3331 | 11' COMMERCIAL PELLET WAGGLER | 11' (3.30M) | 171CM      | 2     | *       | 4-10G    | 4-10LB/1.8-4.5KG | 1  | 25      | €59.95 |



# IMPAX

- › Semi-progressive power action
- › 24T Carbon-curve blanks furnished with ultra-light guides
- › Handle section features a carbon wrap design
- › Oversized hook keeper
- › Both rods feature two 3.5mm quiver tips (1.5oz CF and 2oz GF)
- › Handles combine cork and EVA grips with embossed Nytro logo
- › Half-mat black finish with epoxy varnished guide wrapping
- › Screw-down reel seat
- › Two Powerhouse models ideal for short to medium range Method and bomb fishing
- › Ideal for fishing snake-lake type venues
- › Supplied in a rod bag
- › Butt caps feature epoxy Nytro logo

## IMPAX POWER METHOD SERIES



**CRBN CARBON-CURVE**  **Ø3.5MM TIPS**

The Impax Power Method 80 joins the IMPAX range of feeder rods as its most robust addition. This powerhouse model is designed to boss and land big fish with ease. It's the ideal choice and length fishing 'snake lake' style venues.

Available in both 8ft and 9ft lengths, the Power Method Feeder rods feature a slim 24T Carbon-curve blank with sufficient power reserves. Each rod comes with two 3.5mm tips, one 1.5oz carbon and one 2oz glass tip, equipped with large lined guides for optimal performance. The rod blank is equipped with modern, ultra-light guides, while the butt section is reinforced with a carbon wrap for added durability. The handle merges cork and EVA materials, offering a comfortable and secure grip.



| CODE     | TREF  | DESCRIPTION               | LENGTH    | TR. LENGTH | SECT | TIPS      | C/WEIGHT | LINE RATING      | SU | CTN QTY | RRP    |
|----------|-------|---------------------------|-----------|------------|------|-----------|----------|------------------|----|---------|--------|
| 20200120 | T3331 | POWER METHOD 80           | 8"(2.40M) | 127CM      | 2+2  | 1.5 & 2OZ | 80G      | 4-10LB/1.8-4.5KG | 1  | 20      | €59.95 |
| 20200121 | T3608 | POWER METHOD 80           | 9"(2.70M) | 136CM      | 2+2  | 1.5 & 2OZ | 80G      | 4-10LB/1.8-4.5KG | 1  | 20      | €64.95 |
| 20200122 | T553  | POWER METHOD TIP 1.5OZ GF | *         | 55CM       | *    | 1.5OZ     | *        | *                | 1  | 50      | €9.95  |
| 20200123 | T997  | POWER METHOD TIP 2OZ CF   | *         | 64CM       | *    | 2OZ       | *        | *                | 1  | 50      | €17.95 |



RODS

NYTRO



RODS



# IMPAX

- Progressive through, allround action
- 24T Carbon-curve blanks furnished with ultra-light guides
- Handle section features a carbon wrap design
- Oversized hook keeper
- All feeder rods feature two 2.5mm carbon quiver tips
- Handles combine cork and EVA grips
- Half-mat black finish with epoxy varnished guide wrapping
- Screw-down reel seat
- Six different models for most allround feeder fishing conditions
- Supplied in a rod bag
- Butt caps feature epoxy Nytro logo



## IMPAX ALLROUNDER SERIES



CRBN CARBON-CURVE  Ø2.5MM TIPS

This range of entry-level Impax ALLROUNDER rods with ultra-light minima-style guides, have been developed to offer a range of rods that anglers can fish throughout the year. Whether fishing at close-range for roach and skimmers or long distance for bream, whether at a commercial for carp or in natural venues. The Impax ALLROUNDER does as it says on the tin. All rods come with two dedicated 2.5mm carbon quiver tips. A full range of four different tips are available, from 0.75oz to 2oz.



| CODE     | TREF  | DESCRIPTION                          | LENGTH      | TR. LENGTH | SECT. | TIPS       | C/WEIGHT | SU | CTN QTY | RRP    |
|----------|-------|--------------------------------------|-------------|------------|-------|------------|----------|----|---------|--------|
| 20200070 | T2497 | ALLROUNDER 8'                        | 8' (2.40M)  | 127CM      | 2+2   | 0.75 & 1OZ | 20G      | 1  | 25      | €44.95 |
| 20200071 | T2775 | ALLROUNDER 9'                        | 9' (2.70M)  | 142CM      | 2+2   | 0.75 & 1OZ | 25G      | 1  | 25      | €49.95 |
| 20200072 | T3053 | ALLROUNDER 10'                       | 10' (3.00M) | 157CM      | 2+2   | 0.75 & 1OZ | 30G      | 1  | 25      | €54.95 |
| 20200073 | T3331 | ALLROUNDER 11'                       | 11' (3.30M) | 118CM      | 3+2   | 1 & 1.5OZ  | 45G      | 1  | 25      | €59.95 |
| 20200074 | T3608 | ALLROUNDER 12'                       | 12' (3.60M) | 126CM      | 3+2   | 1 & 1.5OZ  | 60G      | 1  | 25      | €64.95 |
| 20200075 | T3886 | ALLROUNDER 13'                       | 13' (3.90M) | 137CM      | 3+2   | 1.5 & 2OZ  | 80G      | 1  | 25      | €69.95 |
| 20202276 | T997  | ALLROUNDER TIP 0.75OZ (Ø2.5MM) RED   | *           | 52CM       | *     | 0.75OZ     | *        | 1  | 50      | €17.95 |
| 20200077 | T997  | ALLROUNDER TIP 1OZ (Ø2.5MM) YELLOW   | *           | 52CM       | *     | 1OZ        | *        | 1  | 50      | €17.95 |
| 20200078 | T997  | ALLROUNDER TIP 1.5OZ (Ø2.5MM) ORANGE | *           | 52CM       | *     | 1.5OZ      | *        | 1  | 50      | €17.95 |
| 20200079 | T997  | ALLROUNDER TIP 2OZ (Ø2.5MM) RED      | *           | 52CM       | *     | 2OZ        | *        | 1  | 50      | €17.95 |



- > 8ft / 2.40m: The 8ft Impax Allrounder classifies as your classic picker rod for close range fishing for roach and skimmers. Or as a light bomb-rod on a commercial.
- > 9ft / 2.70m: The 9ft Impax Allrounder classifies as a quiver rod for close range fishing for roach, skimmers and bream. Or as a light bomb and method feeder rod on a commercial.
- > 10ft / 3.00m: The 10ft Impax Allround is the ideal allrounder when it comes to short to medium distance fishing in natural venues and commercials. The 24T carbon-curve blank offers sufficient backbone to challenge bream and bigger FIs.
- > 11ft / 3.30m: The 11ft Impax Allrounder is perfect for fishing up to about 40m with a classic cage, method or hybrid feeder.
- > 12ft / 3.60m: The 12ft Impax Allrounder is probably the most allround length for fishing up to about . 50-60m with a classic cage, method of hybrid feeder, fishing for bream and carp in still and faster flowing waters.
- > 13ft / 3.90m: The 13ft Impact Allrounder is the to-go-to length when you need to reach longer distances in both still water and running water conditions. The 24T carbon-curve blank offers enough power for reaching distance yet has sufficient reserves when reeling in bigger fish.





RODS

NYTRO

# IMPAX

- ✓ Fast and powerful action
- ✓ 24T Carbon-curve blanks furnished with ultra-light guides
- ✓ Handle section features a carbon wrap design
- ✓ Oversized hook keeper
- ✓ All feeder rods feature two carbon quiver tips
- ✓ Handles combine cork and EVA grips
- ✓ Half-mat black finish with epoxy varnished guide wrapping
- ✓ Screw-down reel seat
- ✓ Three casting weights in two different lengths for most distance fishing conditions
- ✓ Supplied in a rod bag
- ✓ Butt cap features epoxy Nytro logo

## IMPAX CONTINENTAL POWER SERIES

NEW

CRBN CARBON-CURVE    Ø3.5MM TIPS

Power feeder rods in a popular price range, that is what these Impax Continental rods are. Designed for fishing with heavier weights and casting longer distances, especially on the continent. Ideal for faster running waters too. We have selected the most popular length (12ft and 13ft) and casting weights (100 – 120 and 150gr) for this type of fishing, resulting in this range of six different models with a faster and more power action. Allowing for improved balance and lighter weight, these rods are designed with ultra-light minima-style guides. All rods feature two dedicated 3.5mm carbon tips, ranging from 1.5oz to 4oz.



| CODE     | TREF  | DESCRIPTION                                 | LENGTH      | TR. LENGTH | SECT. | TIPS      | C/WEIGHT | SU | CTN QTY | RRP    |
|----------|-------|---|-------------|------------|-------|-----------|----------|----|---------|--------|
| 20200080 | T3886 | CONTINENTAL POWER FEEDER 12'                | 12' (3.60M) | 126CM      | 3+2   | 1.5 & 2OZ | 100G     | 1  | 25      | €69.95 |
| 20200081 | T4164 | CONTINENTAL POWER FEEDER 13'                | 13' (3.90M) | 136CM      | 3+2   | 1.5 & 2OZ | 100G     | 1  | 25      | €74.95 |
| 20200082 | T4053 | CONTINENTAL POWER FEEDER 12'                | 12' (3.60M) | 126CM      | 3+2   | 2 & 3OZ   | 120G     | 1  | 25      | €72.95 |
| 20200083 | T4331 | CONTINENTAL POWER FEEDER 13'                | 13' (3.90M) | 136CM      | 3+2   | 2 & 3OZ   | 120G     | 1  | 25      | €77.95 |
| 20200084 | T4164 | CONTINENTAL POWER FEEDER 12'                | 12' (3.60M) | 126CM      | 3+2   | 3 & 4OZ   | 150G     | 1  | 25      | €74.95 |
| 20200085 | T4442 | CONTINENTAL POWER FEEDER 13'                | 13' (3.90M) | 137CM      | 3+2   | 3 & 4OZ   | 150G     | 1  | 25      | €79.95 |
| 20200086 | T997  | CONTINENTAL POWER TIP 1.5OZ (Ø3.5MM) ORANGE | *           | *          | *     | 1.5OZ     | *        | 1  | 50      | €17.95 |
| 20200087 | T997  | CONTINENTAL POWER TIP 2OZ (Ø3.5MM) RED      | *           | *          | *     | 2OZ       | *        | 1  | 50      | €17.95 |
| 20200088 | T997  | CONTINENTAL POWER TIP 3OZ (Ø3.5MM) YELLOW   | *           | *          | *     | 3OZ       | *        | 1  | 50      | €17.95 |
| 20200089 | T997  | CONTINENTAL POWER TIP 4OZ (Ø3.5MM) GREEN    | *           | *          | *     | 4OZ       | *        | 1  | 50      | €17.95 |

# AnglingTimes

NYTRO 9FT COMMERCIAL CARP FEEDER

LIVE TEST



**“A LOT OF BANG FOR YOUR BUCK!”**

MARK SAWYER, TACKLE EDITOR

NYTRO IMPAX COMMERCIAL PELLET WAGGLER 10FT

LIVE TEST

**“THE ROD’S LINE PICK-UP SPEED  
WAS PARTICULARLY IMPRESSIVE”**

MARK SAWYER, TACKLE EDITOR



NYTRO ARYZON METHOD FEEDER 12 FT

LIVE TEST



**“A SUBLIME ROD THAT’S  
EXCELLENT VALUE!”**

MARK SAWYER, TACKLE EDITOR

**NYTRO**  
performance first



RODS

NYTRO

# ARYZON

- > Seamless through action
- > Lightweight 30T carbon-curve blanks
- > High quality black anodized line guides
- > Hook keeper
- > All feeder rods feature two carbon quiver tips
- > Handles combine durable cork and EVA grips
- > Special EVA handle for better control
- > Half-matt black finish with epoxy varnished black guide wrapping
- > Screw-down reel seat
- > Supplied in a rod bag
- > Butt caps feature epoxy Nytro logo

## ARYZON COMMERCIAL SERIES

**30T CARBON-CURVE**  **Ø2.5MM TIPS**

When you are looking for a seamless, powerful, yet forgiving through action rod, in a range that covers just about every discipline on a commercial fishery, look no further! The Aryzon range of rods are exactly that! Starting with the Carp Feeder rod in 9ft, 10ft and 11ft models, for short, medium and long-distance casting. Aryzon rods are lightweight and well balanced, yet offer the right amount of power to be in control of a fish very quickly, especially right before netting.

**ARYZON METHOD FEEDER:** There is also a 12ft Method Feeder which, with its heavier casting weight, allows you to cast distances up to 60-70m. These rods offer sufficient power to take control of larger fish very quickly.

**ARYZON PELLET WAGGLER:** This series also features two, 10ft and 11ft, Pellet Wagglers which are designed for casting floats either short, medium or longer ranges. Aryzon rods are lightweight and well balanced, yet offer the right amount of power to be in control of a fish very quickly, especially right before netting.



| CODE     | TREF  | DESCRIPTION             | LENGTH      | TR. LENGTH | SECT. | TIPS    | C/WEIGHT | LINE RATING      | SU | CTN QTY | RRP     |
|----------|-------|-------------------------|-------------|------------|-------|---------|----------|------------------|----|---------|---------|
| 20200032 | T4997 | 9' CARP FEEDER          | 9' (2.70M)  | 142CM      | 2+2   | 1 & 2OZ | 30G      | 5-10LB/2.2-4.5KG | 1  | 10      | €89.95  |
| 20200033 | T5553 | 10' CARP FEEDER         | 10' (3.00M) | 156CM      | 2+2   | 1 & 2OZ | 40G      | 5-10LB/2.2-4.5KG | 1  | 10      | €99.95  |
| 20200034 | T6108 | 11' CARP FEEDER         | 11' (3.30M) | 173CM      | 2+2   | 1 & 2OZ | 50G      | 5-10LB/2.2-4.5KG | 1  | 10      | €109.95 |
| 20200035 | T6664 | 12' METHOD FEEDER       | 12' (3.60M) | 188CM      | 2+2   | 1 & 2OZ | 60G      | 6-10LB/2.7-4.5KG | 1  | 10      | €119.95 |
| 20200036 | T1108 | TIP 1OZ (Ø2.5MM) ORANGE | *           | *          | *     | 1OZ     | *        | *                | 1  | 50      | €19.95  |
| 20200037 | T1108 | TIP 2OZ (Ø2.5MM) YELLOW | *           | *          | *     | 2OZ     | *        | *                | 1  | 50      | €19.95  |
| 20200030 | T5553 | 10' PELLET WAGGLER      | 10' (3.00M) | 142CM      | *     |         | 4-10     | 4-8LB/1.8-3.6KG  | 1  | 10      | €99.95  |
| 20200031 | T6108 | 11' PELLET WAGGLER      | 11' (3.30M) | 172CM      | *     |         | 4-10     | 4-8LB/1.8-3.6KG  | 1  | 10      | €109.95 |

# ARYZON



RODS

NYTRO

- > Strong action for casting heavy bait-up feeders and small spods
- > Pure Carbon-Curve blanks
- > Gunsmoke K-style guides for distance casting
- > Hook keeper
- > Full shrink tube handle with flare
- > Half-matt black finish with epoxy varnished black guide wrapping
- > DPS-type reel seat
- > Supplied in a rod bag
- > Aluminium butt cap featuring the 'N' logo

## ARYZON DISTANCE POWER BAIT-UP SERIES

CARBON-CURVE

COMPATIBLE WITH:  
ARYZON BAIT-UP REEL



Bait-up rods are becoming increasingly popular for baiting up your swim quicker and with larger quantities of bait. Thereby, a bait-up rod allows you to cast heavier weights more accurately at the intended distance, without the risk of breaking off. We have designed the 12' Aryzon Distance Power Bait-up rod to be powerful enough for casting out big bait-up feeders at medium to long range distances. They are also powerful enough to launch smaller bait rockets and mini spods too. For effortless distance casting, this blank, from the start of the cast loads the right amount of strength to cast a bait-up feeder packed with groundbait, far and accurately. The strength in the tip section of the blank also allows you to empty your feeder with one strong pull.

To compliment the Aryzon Distance Power Bait Up Rod we have also produced the Aryzon Bait-up Reel and Braid.

See pages: 40 and 45



| CODE     | TREF  | DESCRIPTION                       | LENGTH      | TR. LENGTH | SECT. | C/WEIGHT | SU | CTN QTY | RRP    |
|----------|-------|-----------------------------------|-------------|------------|-------|----------|----|---------|--------|
| 20200139 | T4442 | ARYZON DISTANCE POWER BAIT-UP ROD | 12' (3.65M) | 185CM      | 2     | 120G     | 1  | 20      | €79.95 |



RODS

NYTRO

# ARYZON

- > Powerful progressive action
- > Pure carbon-curve blanks
- > Black anodized, anti-tangle distance guides
- > Hook keeper
- > All feeder rods feature two carbon quiver tips (2.9mm and 3.4mm)
- > Handles combine high density EVA and rubber cork grips
- > Half-matt black finish with epoxy varnished black guide wrapping
- > Screw-down reel seat
- > Six different models
- > Supplied in a rod bag
- > Butt caps feature epoxy NyTRO logo

## ARYZON CONTINENTAL SERIES

GRN CARBON-CURVE Ø2.9MM & 3.4MM TIPS



These rods radiate stealth and power and are designed for fishing big, natural European venues. Superb actions that help the angler to cast further and even more accurately, whilst retaining a controlled bend when playing hooked fish. Ideal rods when fishing for larger species or when heavier feeders are required. The 3.60m is perfect for casting with 60g up to about 60 meters. If longer casts or heavier feeders are required, then the 3.8m and 4.0m versions are the perfect choice.

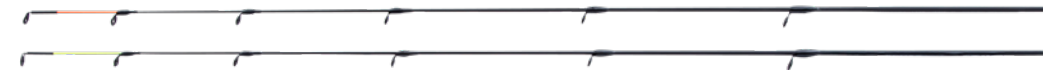

| CODE     | TREF  | DESCRIPTION                                  | LENGTH        | TR. LENGTH | SECT. | TIPS                   | C/WEIGHT | SU | CTN QTY | RRP     |
|----------|-------|--|---------------|------------|-------|------------------------|----------|----|---------|---------|
| 20200038 | T4997 | CONTINENTAL FEEDER 330 50GR                  | 11' (3.30M)   | 171CM      | 2+2   | 1 & 1.5OZ <sup>1</sup> | 50G      | 1  | 20      | €89.95  |
| 20200039 | T5553 | CONTINENTAL FEEDER 360 60GR                  | 12' (3.60M)   | 186CM      | 2+2   | 1 & 2OZ <sup>1</sup>   | 60G      | 1  | 20      | €99.95  |
| 20200040 | T5553 | CONTINENTAL FEEDER 380 80GR                  | 12.8' (3.80M) | 133CM      | 3+2   | 2 & 2.5OZ <sup>1</sup> | 80G      | 1  | 20      | €99.95  |
| 20200041 | T6108 | CONTINENTAL FEEDER 400 100GR                 | 13.2' (4.00M) | 139CM      | 3+2   | 2 & 3OZ <sup>2</sup>   | 100G     | 1  | 20      | €109.95 |
| 20200042 | T6108 | CONTINENTAL FEEDER 400 130GR                 | 13.2' (4.00M) | 139CM      | 3+2   | 2 & 3OZ <sup>2</sup>   | 130G     | 1  | 20      | €109.95 |
| 20200043 | T6664 | CONTINENTAL FEEDER 400 160GR                 | 13.2' (4.00M) | 139CM      | 3+2   | 3 & 4OZ <sup>2</sup>   | 160G     | 1  | 20      | €119.95 |
| 20200044 | T1219 | CONFEEEDER TIP 1OZ (Ø2.9MM) ORANGE           | *             | *          | *     | 1OZ                    | *        | 1  | 50      | €21.95  |
| 20200045 | T1219 | CONTINENTAL FEEDER TIP 1.5OZ (Ø2.9MM) YELLOW | *             | *          | *     | 1.5OZ                  | *        | 1  | 50      | €21.95  |
| 20200046 | T1219 | CONTINENTAL FEEDER TIP 2OZ (Ø2.9MM) RED      | *             | *          | *     | 2OZ                    | *        | 1  | 50      | €21.95  |
| 20200047 | T1219 | CONTINENTAL FEEDER TIP 2.5OZ (Ø2.9MM) ORANGE | *             | *          | *     | 2.5OZ                  | *        | 1  | 50      | €21.95  |
| 20200048 | T1219 | CONTINENTAL FEEDER TIP 2OZ (Ø3.4MM) RED      | *             | *          | *     | 2OZ                    | *        | 1  | 50      | €21.95  |
| 20200049 | T1219 | CONTINENTAL FEEDER TIP 3OZ (Ø3.4MM) ORANGE   | *             | *          | *     | 3OZ                    | *        | 1  | 50      | €21.95  |
| 20200050 | T1219 | CONTINENTAL FEEDER TIP 4OZ (Ø3.4MM) YELLOW   | *             | *          | *     | 4OZ                    | *        | 1  | 50      | €21.95  |

<sup>1</sup> Ø2.9MM <sup>2</sup> Ø3.4MM



# ARYZON



RODS



- > Powerful, fast action
- > Pure Carbon-Curve blanks with carbon tape X-wrapping on handle section
- > Black anodized, ultra -lightweight Minima-style guides
- > Hook keeper
- > All rods feature two 2.9mm carbon quiver tips
- > Handles combine high density EVA and rubber cork grips
- > Half-mat black finish with epoxy varnished black guide wrapping
- > Four of the most popular lengths
- > Supplied in a rod bag
- > Butt cap with epoxy logo

## ARYZON DISTANCE POWER SERIES



**CRBN CARBON-CURVE**  **Ø2.9MM TIPS**

These fast tapered Distance Power Feeder rods have been developed to cast long distances on bigger venues. The other major advantage of a fast tapered blank is that it helps pick-up the line quicker on the strike, which is important when fishing at long ranges. For advanced casting efficiency these rods come with oversized guides, all the way to the tip. Each rod in the range is supplied with two dedicated carbon tips. A wider range of five different interchangeable carbon tips 1oz, 1.5oz, 2oz, 3oz, 4oz, 5oz and 6oz, are also available.

New for 2025 are the 12'6" and 14' rods that were requested to complement the range for long range distance fishing on fast flowing rivers, where you need to keep as much line out of the water as possible.

With the lighter tips available, these rods work well for a wide range of fishing from targeting roach, skimmers, bream and even carp on larger venues and running water.

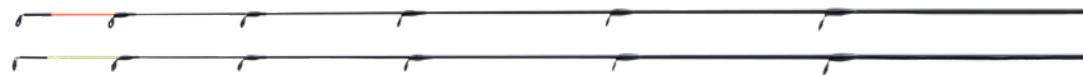

| CODE     | TREF  | DESCRIPTION                          | LENGTH                   | TR. LENGTH | SECT. | TIPS      | C/WEIGHT | SU | CTN QTY | RRP     |
|----------|-------|--------------------------------------|--------------------------|------------|-------|-----------|----------|----|---------|---------|
| 20200090 | T5553 | DISTANCE POWER FEEDER 80GR           | 12' (3.60M)              | 126CM      | 3+2   | 1 & 1.5OZ | 80G      | 1  | 20      | €99.95  |
| 20200124 | T5831 | DISTANCE POWER FEEDER 100GR          | <b>NEW</b> 12.6' (3.80M) | *          | 2+2   | 1.5 & 2OZ | 100G     | 1  | 25      | €104.95 |
| 20200091 | T5831 | DISTANCE POWER FEEDER 120GR          | 13' (3.90M)              | 136CM      | 3+2   | 1.5 & 2OZ | 120G     | 1  | 20      | €104.95 |
| 20200092 | T6386 | DISTANCE POWER FEEDER 60GR           | 13' (3.90M)              | 136CM      | 3+2   | 2 & 3OZ   | 160G     | 1  | 20      | €114.95 |
| 20200093 | T6942 | DISTANCE POWER FEEDER 200GR          | 13' (3.90M)              | 136CM      | 3+2   | 3 & 4OZ   | 200G     | 1  | 20      | €124.95 |
| 20200125 | T7108 | DISTANCE POWER FEEDER 120GR          | <b>NEW</b> 14' (4.20M)   | *          | 3+2   | 2 & 3OZ   | 120G     | 1  | 25      | €127.95 |
| 20200126 | T7219 | DISTANCE POWER FEEDER 160GR          | <b>NEW</b> 14' (4.20M)   | *          | 3+2   | 2 & 3OZ   | 160G     | 1  | 25      | €129.95 |
| 20200094 | T1219 | DISTANCE POWER FEEDER 10Z TIP ORANGE | *                        | *          | *     | 10Z       | *        | 1  | 50      | €21.95  |
| 20200095 | T1219 | DISTANCE POWER FEEDER 1.5OZ TIP RED  | *                        | *          | *     | 1.5OZ     | *        | 1  | 50      | €21.95  |
| 20200096 | T1219 | DISTANCE POWER FEEDER 2OZ TIP YELLOW | *                        | *          | *     | 2OZ       | *        | 1  | 50      | €21.95  |
| 20200097 | T1219 | DISTANCE POWER FEEDER 3OZ TIP ORANGE | *                        | *          | *     | 3OZ       | *        | 1  | 50      | €21.95  |
| 20200098 | T1219 | DISTANCE POWER FEEDER 4OZ TIP RED    | *                        | *          | *     | 4OZ       | *        | 1  | 50      | €21.95  |
| 20200127 | T1219 | DISTANCE POWER FEEDER 5OZ TIP GREEN  | <b>NEW</b> *             | *          | *     | 5OZ       | *        | 1  | 50      | €21.95  |
| 20200128 | T1219 | DISTANCE POWER FEEDER 6OZ TIP RED    | <b>NEW</b> *             | *          | *     | 6OZ       | *        | 1  | 50      | €21.95  |



RODS

NYTRO

# STARKX

- › Strong action for casting heavy feeders and playing big fish
- › Pure carbon-curve blanks
- › Black anodized guides
- › Hook keeper
- › All rods feature two 3.5mm carbon quiver tips
- › Handles combine high density EVA and cork grips
- › Half-matt black finish with epoxy varnished black guide wrapping
- › DPS-type reel seat with down locking EVA hood
- › Six different models available from 90g to 150g casting
- › Supplied in a rod bag
- › Rubber-cork butt caps features epoxy NyTRO logo



## STARKX METHOD SERIES

CARBON-CURVE      Ø3.5MM TIPS

StarkX Method rods are designed to cast heavy Method and hybrid feeders a long way. These rods are designed to withstand the pressure of big casts and playing big fish. StarkX Method rods are designed for fishing large European venues and come in six different models, from heavy to X-heavy actions. All rods feature two carbon quiver tips.

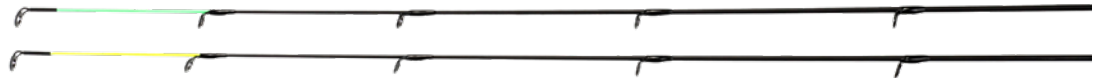

| CODE     | TREF  | DESCRIPTION             | LENGTH      | TR. LENGTH | SECT. | TIPS    | C/WEIGHT | LINE RATING      | SU | CTN QTY | RRP    |
|----------|-------|-------------------------|-------------|------------|-------|---------|----------|------------------|----|---------|--------|
| 20200051 | T3886 | 330H METHOD 90 11'      | 11' (3.30M) | 115CM      | 3+2   | 3 & 4OZ | 30-90G   | 8-14LB/3.6-6.3KG | 1  | 20      | €69.95 |
| 20200052 | T4442 | 360H METHOD 100 12'     | 12' (3.60M) | 125CM      | 3+2   | 3 & 4OZ | 40-100G  | 8-14LB/3.6-6.3KG | 1  | 20      | €79.95 |
| 20200053 | T4442 | 360XH METHOD 140 12'    | 12' (3.60M) | 125CM      | 3+2   | 4 & 5OZ | 50-140G  | 8-14LB/3.6-6.3KG | 1  | 20      | €79.95 |
| 20200054 | T4997 | 390H METHOD 100 13'     | 13' (3.90M) | 135CM      | 3+2   | 3 & 4OZ | 40-100G  | 8-14LB/3.6-6.3KG | 1  | 20      | €89.95 |
| 20200055 | T4997 | 390XH METHOD 150 13'    | 13' (3.90M) | 135CM      | 3+2   | 4 & 5OZ | 50-150G  | 8-14LB/3.6-6.3KG | 1  | 20      | €89.95 |
| 20200056 | T5553 | 420XH METHOD 150 14'    | 14' (4.20M) | 145CM      | 3+2   | 4 & 5OZ | 50-150G  | 8-14LB/3.6-6.3KG | 1  | 20      | €99.95 |
| 20200067 | T1219 | TIP 3OZ (Ø3.5MM) ORANGE | *           | *          | *     | 3OZ     | *        | *                | 1  | 50      | €21.95 |
| 20200068 | T1219 | TIP 4OZ (Ø3.5MM) YELLOW | *           | *          | *     | 4OZ     | *        | *                | 1  | 50      | €21.95 |
| 20200069 | T1219 | TIP 5OZ (Ø3.5MM) GREEN  | *           | *          | *     | 5OZ     | *        | *                | 1  | 50      | €21.95 |

# STARKX

- › Strong action for casting heavy feeders and playing big fish
- › Pure carbon-curve blanks
- › Black anodized guides
- › Hook keeper
- › All rods feature two 3.5mm carbon quiver tips
- › Handles combine high density EVA and cork grips
- › Half-matt black finish with epoxy varnished black guide wrapping
- › DPS-type reel seat with down locking EVA hood
- › Eight different models from 60g to 200g casting weight
- › Supplied in a rod bag
- › Rubber-cork butt caps features epoxy Nytro logo



RODS



## STARKX BIG RIVER SERIES

**CRBN CARBON-CURVE**  **Ø3.5MM TIPS**

StarkX Big River rods are designed for casting heavy feeders and playing big fish. These blanks are just perfect for fishing larger natural venues and especially fast flowing rivers. Tested to the limit, anglers will appreciate the power that these rods have to offer. The Big River series comes in eight different models from MH to XXH actions with up to 200g casting weight. A variety of five different fully interchangeable 3.5mm quiver tips are available.

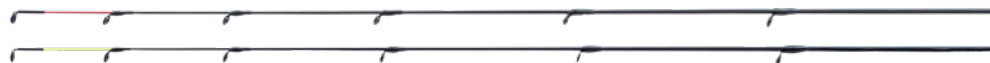
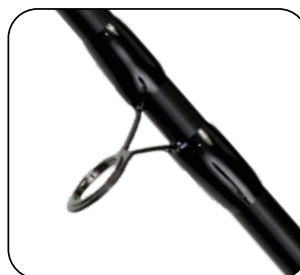

| CODE     | TREF  | DESCRIPTION                 | LENGTH      | TR. LENGTH | SECT. | TIPS      | C/WEIGHT | SU | CTN QTY | RRP     |
|----------|-------|-----------------------------|-------------|------------|-------|-----------|----------|----|---------|---------|
| 20200057 | T5553 | BIG RIVER 330MH FEEDER 60   | 11' (3.30M) | 115CM      | 3+2   | 1 & 1.5OZ | 20-60G   | 1  | 20      | €99.95  |
| 20200058 | T5553 | BIG RIVER 330H FEEDER 100   | 11' (3.30M) | 115CM      | 3+2   | 2 & 3OZ   | 40-100G  | 1  | 20      | €99.95  |
| 20200059 | T6108 | BIG RIVER 360MH FEEDER 80   | 12' (3.60M) | 125CM      | 3+2   | 1.5 & 2OZ | 20-80G   | 1  | 20      | €109.95 |
| 20200060 | T6108 | BIG RIVER 360H FEEDER 100   | 12' (3.60M) | 125CM      | 3+2   | 2 & 3OZ   | 40-100G  | 1  | 20      | €109.95 |
| 20200061 | T6386 | BIG RIVER 390H FEEDER 100   | 13' (3.90M) | 135CM      | 3+2   | 2 & 3OZ   | 40-100G  | 1  | 20      | €114.95 |
| 20200062 | T6386 | BIG RIVER 390XH FEEDER 150  | 13' (3.90M) | 135CM      | 3+2   | 3 & 4OZ   | 80-150G  | 1  | 20      | €114.95 |
| 20200063 | T6664 | BIG RIVER 420XH FEEDER 150  | 14' (4.20M) | 145CM      | 3+2   | 3 & 4OZ   | 50-150G  | 1  | 50      | €119.95 |
| 20200064 | T7219 | BIG RIVER 420XXH FEEDER 200 | 14' (4.20M) | 145CM      | 3+2   | 4 & 5OZ   | 80-200G  | 1  | 50      | €129.95 |
| 20200065 | T1219 | TIP 1.5OZ (Ø3.5MM) RED      | *           | *          | *     | 1.5OZ     | *        | 1  | 50      | €21.95  |
| 20200066 | T1219 | TIP 2OZ (Ø3.5MM) YELLOW     | *           | *          | *     | 2OZ       | *        | 1  | 50      | €21.95  |
| 20200067 | T1219 | TIP 3OZ (Ø3.5MM) ORANGE     | *           | *          | *     | 3OZ       | *        | 1  | 50      | €21.95  |
| 20200068 | T1219 | TIP 4OZ (Ø3.5MM) YELLOW     | *           | *          | *     | 4OZ       | *        | 1  | 50      | €21.95  |
| 20200069 | T1219 | TIP 5OZ (Ø3.5MM) GREEN      | *           | *          | *     | 5OZ       | *        | 1  | 50      | €21.95  |



RODS



# MARVELIST

- › Designed in close cooperation with feeder legend and former World Champion, Tommy Pickering
- › Progressive through-action leaving sufficient reserves in the spine
- › High-modulus diamond carbon-curve blanks combining 30T and 40T
- › Carbon wrap on handle section
- › Oversized hook keeper
- › All feeder rods feature three dedicated 2.5mm carbon quiver tips
- › Handles combine flat-grip cork and duplon
- › Half mat black finish with epoxy varnished guide wrapping
- › Screw-down reel seat
- › Four different ranges (Light Carp, Carp, Allrounder and Power Feeder), each in different lengths for most Commercial and Allround Feeder fishing conditions
- › Supplied in a rod bag
- › Butt cap features epoxy Nytro logo

## MARVELIST TPS SERIES LIGHT CARP & CARP

**CBN CARBON-CURVE**  **Ø2.5MM TIPS**

The Marvelist TPS series is available in four ranges: Two commercial ranges, the Light Carp and Carp in 9', 10' and 11'. The Allrounder in 11', 12' and 13' plus, the new Power Feeder in 12' and 13'. They have all been designed in close cooperation with Feeder legend and former World Champion, Tommy Pickering. The rods are purposely designed to cover a wide range of fishing styles and for a multitude of species throughout the fishing seasons. The Light Carp and Carp ranges are two-piece rods with equal sections, featuring three, 2.5mm carbon tips. The Allrounder rods are three-piece rods with equal sections, also featuring three, 2.5mm carbon tips, allowing them all to be interchangeable. The rods are built with high modulus 30T and 40T carbon, allowing them to cast very accurately, offering a fast recovery and improved playing action, with sufficient reserves in the spine of the blank.



| CODE     | TREF  | DESCRIPTION                           | LENGTH      | TR. LENGTH | SECT. | TIPS            | C/WEIGHT | LINE RATING      | SU | CTN | QTY     | RRP |
|----------|-------|---------------------------------------|-------------|------------|-------|-----------------|----------|------------------|----|-----|---------|-----|
| 20200099 | T6108 | 9' LIGHT CARP                         | 9' (2.70M)  | 139CM      | 2+3   | 0.75, 1 & 1.5OZ | 30G      | 4-8LB/1.8-3.6KG  | 1  | 25  | €109.95 |     |
| 20200100 | T6664 | 10' LIGHT CARP                        | 10' (3.00M) | 153CM      | 2+3   | 0.75, 1 & 1.5OZ | 40G      | 4-8LB/1.8-3.6KG  | 1  | 25  | €119.95 |     |
| 20200101 | T7219 | 11' LIGHT CARP                        | 11' (3.30M) | 173CM      | 2+3   | 0.75, 1 & 1.5OZ | 50G      | 5-10LB/2.2-4.5KG | 1  | 25  | €129.95 |     |
| 20200102 | T6108 | 9' CARP                               | 9' (2.70M)  | 149CM      | 2+3   | 0.75, 1 & 1.5OZ | 30G      | 5-10LB/2.2-4.5KG | 1  | 25  | €109.95 |     |
| 20200103 | T6664 | 10' CARP                              | 10' (3.00M) | 163CM      | 2+3   | 1, 1.5 & 2OZ    | 40G      | 5-10LB/2.2-4.5KG | 1  | 25  | €119.95 |     |
| 20200104 | T7219 | 11' CARP                              | 11' (3.30M) | 180CM      | 2+3   | 1, 1.5 & 2OZ    | 50G      | 5-10LB/2.2-4.5KG | 1  | 25  | €129.95 |     |
| 20200105 | T1386 | CARP FEEDER TIP 0.75OZ (Ø2.5MM) RED   | *           | 51CM       | *     | 0.75OZ          | *        | *                | 1  | 50  | €24.95  |     |
| 20200106 | T1386 | CARP FEEDER TIP 1OZ (Ø2.5MM) YELLOW   | *           | 51CM       | *     | 1OZ             | *        | *                | 1  | 50  | €24.95  |     |
| 20200107 | T1386 | CARP FEEDER TIP 1.5OZ (Ø2.5MM) ORANGE | *           | 51CM       | *     | 1.5OZ           | *        | *                | 1  | 50  | €24.95  |     |
| 20200108 | T1386 | CARP FEEDER TIP 2OZ (Ø2.5MM) RED      | *           | 51CM       | *     | 2OZ             | *        | *                | 1  | 50  | €24.95  |     |

# MARVELIST



RODS

NYTRO



## MARVELIST

Tommy Pickering on the MARVELIST TPS SERIES LIGHT CARP

*"These rods are so versatile that I use them all year round. In the summer they are my bream and skimmer rods and in the winter, they are my go-to carp rods, especially when using smaller hooks and lighter lines."*



## MARVELIST

Tommy Pickering on the MARVELIST TPS SERIES CARP

*"These are my out-and-out carp rods, especially in summer when using hooks size 16 and bigger and if I want to use bigger feeders to gain distance."*





RODS



# MARVELIST

- › Designed in close cooperation with feeder legend and former World Champion, Tommy Pickering
- › Progressive through-action leaving sufficient reserves in the spine
- › High-modulus diamond carbon-curve blanks combining 30T and 40T
- › Carbon wrap on handle section
- › Oversized hook keeper
- › All feeder rods feature three dedicated 2.5mm carbon quiver tips
- › Handles combine flat-grip cork and duplon
- › Half mat black finish with epoxy varnished guide wrapping
- › Screw-down reel seat
- › Four different ranges (Light Carp, Carp, Allrounder and Power Feeder), each in different lengths for most Commercial and Allround Feeder fishing conditions
- › Supplied in a rod bag
- › Butt cap features epoxy Nytro logo







## MARVELIST TPS SERIES ALLROUNDER & POWER FEEDER

NEW

GREN CARBON-CURVE  Ø2.5MM & 2.9MM TIPS

The Marvelist TPS series is available in four ranges: Two commercial ranges, the Light Carp and Carp in 9', 10' and 11'. The Allrounder in 11', 12' and 13' plus, the new Power Feeder in 12' and 13'. They have all been designed in close cooperation with Feeder legend and former World Champion, Tommy Pickering. The rods are purposely designed to cover a wide range of fishing styles and for a multitude of species throughout the fishing seasons. The Allrounder and Power Feeder ranges are three-piece rods with equal sections, also featuring three, resp. 2.5mm and 2.9mm carbon tips. The rods are built with high modulus 30T and 40T carbon, allowing them to cast very accurately, offering a fast recovery and improved playing action, with sufficient reserves in the spine of the blank.



| CODE     | TREF  | DESCRIPTION                          | LENGTH  | TR. LENGTH | SECT. | TIPS                       | C/WEIGHT | LINE RATING      | SU | CTN | QTY | RRP     |
|----------|-------|--------------------------------------|---|------------|-------|----------------------------|----------|------------------|----|-----|-----|---------|
| 20200109 | T8331 | 11' ALLROUNDER                       | 11' (3.30M)   | 139CM      | 3+3   | 1.15 & 2OZ <sup>1</sup>    | 40G      | 5-10LB/2.2-4.5KG | 1  | 25  |     | €149.95 |
| 20200110 | T8886 | 12' ALLROUNDER                       | 12' (3.60M)   | 153CM      | 3+3   | 1.15 & 2OZ <sup>1</sup>    | 60G      | 6-10LB/2.7-4.5KG | 1  | 25  |     | €159.95 |
| 20200111 | T9442 | 13' ALLROUNDER                       | 13' (3.90M)   | 173CM      | 3+3   | 1.15 & 2OZ <sup>1</sup>    | 80G      | 6-10LB/2.7-4.5KG | 1  | 25  |     | €169.95 |
| 20200135 | T8886 | POWER FEEDER 12' 100GR               |  12' (3.60M) | 126CM      | 3+3   | 1.5, 2, 2.5OZ <sup>2</sup> | 100G     | 6-10LB/2.7-4.5KG | 1  | 25  |     | €159.95 |
| 20200136 | T9442 | POWER FEEDER 13' 130GR               |  13' (3.90M) | 136CM      | 3+3   | 2, 2.5 & 3OZ <sup>2</sup>  | 130G     | 6-10LB/2.7-4.5KG | 1  | 25  |     | €169.95 |
| 20200112 | T1386 | ALLROUNDER TIP 1.5OZ (Ø2.5MM) ORANGE | *   | *          | *     | 1.5OZ                      | *        | *                | 1  | 50  |     | €24.95  |
| 20200113 | T1386 | ALLROUNDER TIP 2OZ (Ø2.5MM) RED      | *   | *          | *     | 2OZ                        | *        | *                | 1  | 50  |     | €24.95  |
| 20200114 | T1386 | ALLROUNDER TIP 2.5OZ (Ø2.5MM) YELLOW | *   | *          | *     | 2.5OZ                      | *        | *                | 1  | 50  |     | €24.95  |
| 20200115 | T1386 | ALLROUNDER TIP 3OZ (Ø2.5MM) GREEN    | *   | *          | *     | 3OZ                        | *        | *                | 1  | 50  |     | €24.95  |
| 20200149 | T1386 | POWER FEEDER TIP 2.9MM 1.5OZ ORANGE  |  *           | *          | *     | 1.5OZ                      | *        | *                | 1  | 50  |     | €24.95  |
| 20200150 | T1386 | POWER FEEDER TIP 2.9MM 2OZ RED       |  *           | *          | *     | 2OZ                        | *        | *                | 1  | 50  |     | €24.95  |
| 20200151 | T1386 | POWER FEEDER TIP 2.9MM 2.5OZ YELLOW  |  *           | *          | *     | 2.5OZ                      | *        | *                | 1  | 50  |     | €24.95  |
| 20200152 | T1386 | POWER FEEDER TIP 2.9MM 3OZ GREEN     |  *           | *          | *     | 3OZ                        | *        | *                | 1  | 50  |     | €24.95  |

<sup>1</sup> Ø2.5MM <sup>2</sup> Ø2.9MM

# MARVELIST

## Tommy on the MARVELIST TPS SERIES POWER FEEDER

*"I wanted a set of rods that cast that extra bit further and that could handle bigger fish. The Power Feeder rods in the Marvelist range do just that! When I picked up the first 12ft version I simply said, wow".*

*"I was able to test them extensively at the Iberian Masters where they were really put to the test! They are the perfect rods on rivers, lakes and big commercials, where you need that extra power or distance."*



\* All 2.9mm Marvelist POWER FEEDER Quiver tips feature oversized lined guides for improved distance casting.

# MARVELIST

## Tommy Pickering on the MARVELIST TPS SERIES ALLROUNDER

*"If I had to choose only one rod to cover everything, then this is the rod! It can be used on rivers, lakes and commercials."*



\* All 2.5mm Marvelist ALLROUNDER Quiver tips feature oversized lined guides for improved distance casting.



RODS

NYTRO

# MARVELIST

- › 40T carbon blank
- › Slim blanks
- › Minima-style guides
- › Lightweight and perfectly balanced
- › Excellent line and float control
- › Crisp and responsive action
- › Cork handle
- › Supplied in a rod bag
- › Butt cap with epoxy logo

## MARVELIST NATURAL FLOAT SERIES

NEW

### CRB CARBON-CURVE

The Marvelist rod range was developed in close collaboration with former Float Fishing World Champion Tommy Pickering. They are available in Light and Medium actions to suit a wide range of float fishing conditions. Featuring Minima-style line guides, the 40T carbon blanks are perfectly balanced, slim, and lightweight. They are recommended for reel lines between 2.5 – 4lb (0.12-0.18mm). The rods have a rigid, crisp action with minimal bounce for exceptional line and float control. Additionally, the soft tip action acts as a gentle shock absorber, minimizing the risk of hook pulls and allowing the use of lighter hook lengths.



### Tommy on the MARVELIST TPS SERIES FLOAT RODS

*"The Marvelist rods offer such excellent value for money that I felt a tight range of float rods would make perfect sense. I was able to test them during the Veterans Float Fishing World Champs in Bulgaria and I can honestly say I am chuffed with how good these rods are."*



| CODE     | TREF  | DESCRIPTION                | LENGTH      | TR. LENGTH | SECT. | C/WEIGHT | LINE RATING     | SU | CTN QTY | RRP     |
|----------|-------|----------------------------|-------------|------------|-------|----------|-----------------|----|---------|---------|
| 20200132 | T7219 | MARVELIST FLOAT 13' LIGHT  | 13' (3.90M) | 135CM      | 3     | >15G     | 2-4LB/0.9-1.8KG | 1  | 25      | €129.95 |
| 20200133 | T7497 | MARVELIST FLOAT 13' MEDIUM | 13' (3.90M) | 135CM      | 3     | >20G     | 3-6LB/1.4-2.7KG | 1  | 25      | €134.95 |
| 20200134 | T7775 | MARVELIST FLOAT 14' MEDIUM | 14' (4.20M) | 145CM      | 3     | >28G     | 3-7LB/1.4-3.2KG | 1  | 25      | €139.95 |



# STARKX



RODS

NYTRO

- > Semi-fast tapered blank
- > Pure Carbon-Curve blanks with woven carbon on handle section
- > Black anodized, ultra -lightweight Minima-style guides
- > Hook keeper
- > Cork handle
- > Half-mat black finish with epoxy varnished black guide wrapping
- > Supplied in a rod bag
- > Butt cap with epoxy logo

## STARKX SPECIALIST SERIES



CCB CARBON-CURVE

The all-round StarkX Specialist rods are tailored for the modern river angler who is targeting large chub and barbel. These semi-fast tapered rods, feature ultra-lightweight Minima-style line guides, enhancing durability, balance and sensitivity, which provides greater casting distance and accuracy. StarkX rods are lightweight and offer immense power and strength.



| CODE     | TREF  | DESCRIPTION            | LENGTH      | TR. LENGTH | SECT. | C/WEIGHT | LINE RATING      | SU | CTN QTY | RRP    |
|----------|-------|------------------------|-------------|------------|-------|----------|------------------|----|---------|--------|
| 20200129 | T3886 | SPECIALIST 1.75-2LBS   | 12' (3.60M) | 187CM      | 2     | 277G     | 6-12LB/2.7-5.4KG | 1  | 20      | €69.95 |
| 20200130 | T4442 | SPECIALIST 2.25-2.5LBS | 12' (3.60M) | 187CM      | 2     | 316G     | 6-15LB/2.7-6.8KG | 1  | 20      | €79.95 |





RODS



## FIBRE GLASS & CARBON TIPS

A set of 40 universal 2.5mm glass fibre and carbon quiver tips in 8 different models. Available from 0.5oz to 2oz. Suitable for use with a wide variety of popular feeder rods across different brands.

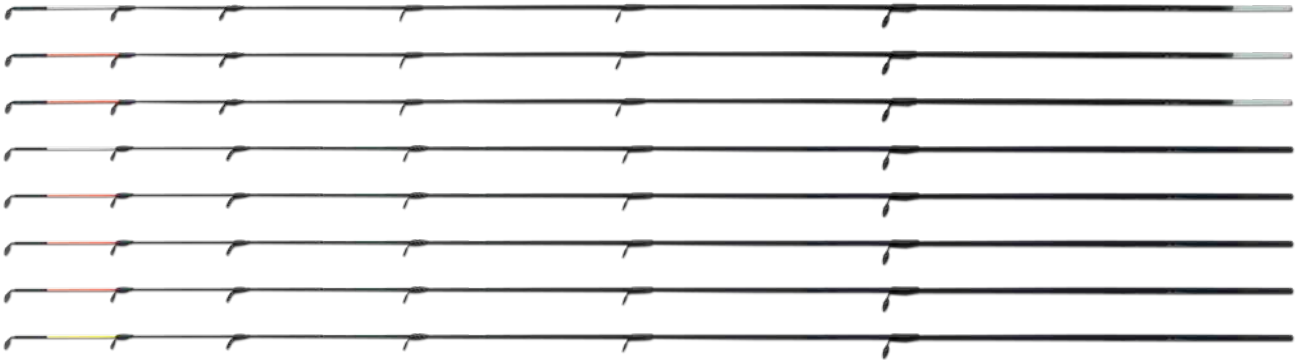

| CODE     | TREF  | DESCRIPTION            | COLOUR | SU | CTN QTY | RRP    |
|----------|-------|------------------------|--------|----|---------|--------|
| 20200140 | T831  | FIBER GLASS TIP 0.5OZ  | WHITE  | 1  | 50      | €14.95 |
| 20200141 | T831  | FIBER GLASS TIP 0.75OZ | ORANGE | 1  | 50      | €14.95 |
| 20200142 | T831  | FIBER GLASS TIP 1OZ    | RED    | 1  | 50      | €14.95 |
| 20200143 | T1386 | CARBON TIP 0.5OZ       | WHITE  | 1  | 50      | €24.95 |
| 20200144 | T1386 | CARBON TIP 0.75OZ      | ORANGE | 1  | 50      | €24.95 |
| 20200145 | T1386 | CARBON TIP 1OZ         | RED    | 1  | 50      | €24.95 |
| 20200146 | T1386 | CARBON TIP 1.5OZ       | ORANGE | 1  | 50      | €24.95 |
| 20200147 | T1386 | CARBON TIP 2OZ         | YELLOW | 1  | 50      | €24.95 |

## POS FEEDER TIP DISPLAY 40 TIPS

| CODE     | TREF   | DESCRIPTION                    | SU | CTN QTY | RRP     |
|----------|--------|--------------------------------|----|---------|---------|
| 20200148 | T31664 | POS FEEDER TIP DISPLAY 40 TIPS | 1  | 10      | €569.95 |





SENTORE



POLES

NYTRO



## IMPAX TELE WHIP WHIP



The Nytro Impax Tele Whip is available in 3m and 4m telescopic lengths. These composite G-fibre poles are ideal for young anglers, newcomers, or anyone on a budget. Nice and light, with a cool design, these poles are perfect for catching roach, perch, skimmers and other smaller species. Very easy to set up by simply extending the whip and attaching a pole rig to the connector at the tip.

- > Composite G-fibre material
- > Telescopic
- > Lightweight
- > Pre fitted connector at the tip
- > Telescopic design
- > Available in 3m and 4m lengths

| CODE     | TREF | DESCRIPTION   | WEIGHT | LENGTH | SECTIONS | TRANSPORT LENGTH | SU | CTN QTY | RRP    |
|----------|------|---------------|--------|--------|----------|------------------|----|---------|--------|
| 20400001 | T608 | IMPAX 3M WHIP | 133G   | 300CM  | 3        | 114CM            | 20 | 50      | €10.95 |
| 20400002 | T719 | IMPAX 4M WHIP | 231G   | 400CM  | 3        | 114CM            | 20 | 50      | €12.95 |

## WHOPPA STOPPA 6M CARP POLE



With a 24-elastic rating, Nytro's Whoppa Stoppa margin pole is a take-apart, 6m, bomb-proof margin pole, that features two elasticated top kits! The pole comes pre-elasticated with an 8-10 hybrid elastic in the pre-bushed tip and in addition, the package includes an extra take-apart top two kit, which is pre-elasticated with 18+ hybrid carp elastic for bigger carp.

- > Lightweight, composite G-fibre blank
- > Exceptionally strong
- > Amazing 24 elastic rating
- > Pre-fitted PTFE bushes
- > Two pre-elasticated top kits (tip: 8-10 and kit 2/1: 18+)
- > Comes fitted with winder bung and key
- > Designed to catch big fish
- > Take-apart design

| CODE     | TREF  | DESCRIPTION                 | WEIGHT | LENGTH | SECTIONS | TRANSPORT LENGTH | SU | CTN QTY | RRP    |
|----------|-------|-----------------------------|--------|--------|----------|------------------|----|---------|--------|
| 20400003 | T3886 | WHOPPA STOPPA 6M MARGIN     | 512G   | 600CM  | 6+2      | 115CM            | 1  | 25      | €69.95 |
| 20400004 | T1053 | WHOPPA STOPPA POWER KIT 2/1 | 53G    | *      | 2        | 100CM            | 1  | 25      | €18.95 |
| 20400005 | T831  | WHOPPA STOPPA MATCH KIT 2/1 | 53G    | *      | 2        | 100CM            | 1  | 25      | €14.95 |



## MARGIN MUNCHER 45 CARP POLE



The Nytro Margin Muncher 4.5m is an exceptionally strong margin pole, perfect for landing the biggest carp when fishing commercials and carpodromes. These bomb-proof take-apart poles feature a progressive action and are designed for use with heavy elastics. Ideal to land large fish quickly. The Margin Muncher comes pre-fitted with a PTFE bush and with a winder bung and extraction key. The number two section comes with an extra carbon reinforcement to allow for a puller bush to be fitted. At 4.5m it is perfect for margin fishing or for those new to pole fishing.

- > Carbon blank
- > Exceptionally strong
- > Pre-fitted PTFE bush
- > Comes fitted with winder bung and key
- > Extra CF reinforced No 2 section
- > Take-apart design

| CODE     | TREF  | DESCRIPTION               | WEIGHT | LENGTH | SECTIONS | TRANSPORT LENGTH | SU | CTN QTY | RRP    |
|----------|-------|---------------------------|--------|--------|----------|------------------|----|---------|--------|
| 20400006 | T3331 | MARGIN MUNCHER 45         | 225G   | 450CM  | 4        | 123CM            | 1  | 20      | €59.95 |
| 20400007 | T1108 | MARGIN MUNCHER 45 KIT 2/1 | 48G    | *      | 2        | 113CM            | 1  | 20      | €19.95 |

## POWER EDGE CARP 60



If you are looking for a robust margin pole, look no further! With its carbon reinforced sections, extra wall thickness and strong joints, the 6m Power Edge provides the perfect combination of strength and rigidity. It allows the angler to fish heavier elastics for catching bigger and more powerful fish. It's the perfect solution for challenging scenarios that need a strong pole.

- > Carbon reinforced blank
- > Extra wall thickness and strong joints
- > Pre-fitted PTFE bush
- > Pre-fitted roller puller
- > Take-apart design

| CODE     | TREF  | DESCRIPTION                | LENGTH | LENGTH | SECTIONS | TRANSPORT LENGTH | SU | CTN QTY | RRP    |
|----------|-------|----------------------------|--------|--------|----------|------------------|----|---------|--------|
| 20400008 | TS191 | POWER EDGE CARP 60         | 369G   | 600CM  | 5        | 137CM            | 1  | 20      | €89.95 |
| 20400009 | T1872 | POWER EDGE CARP 60 KIT 2/1 | 53G    | *      | 2        | 98CM             | 1  | 50      | €29.95 |

# REELS

ARYZON  
LINE CAPACITY 150m / 0.26mm

# NTR



REELS

NYTRO

- > Gear ratio 3002/4002 5.2:1 and 5002 5.1:1
- > Medium-shallow aluminium spool
- > Graphite body and balanced rotor construction
- > S-curve oscillation system
- > Round metal line-clip
- > Micro adjustable front drag
- > One-way clutch system
- > Oversized bail wire
- > Ambidextrous handle



## NTR MK2 3002, 4002 & 5002

Following on from the huge success of the original Nytro NTR reel range, Nytro MK2 reels are now available in three sizes, 3002, 4002 and 5002. These reels have been upgraded and feature a medium-shallow aluminium spool making them ideal for fishing with mono or braid and are suited to both feeder and waggler fishing. The NTR MK2 range of reels offers exceptional performance and value for money.



| CODE     | TREF  | DESCRIPTION        | CAPACITY      | DRAG      | RETRIEVE | WEIGHT | SU | CTN QTY | RRP    |
|----------|-------|--------------------|---------------|-----------|----------|--------|----|---------|--------|
| 20100029 | T1664 | MK2 3002           | M/MM 115/0.20 | 8KG/18LB  | 75CM     | 368G   | 1  | 20      | €29.95 |
| 20100030 | T1831 | MK2 4002           | M/MM 200/0.22 | 8KG/18LB  | 85CM     | 276G   | 1  | 20      | €32.95 |
| 20100031 | T1942 | MK2 5002           | M/MM 200/0.25 | 11KG/24LB | 90CM     | 354G   | 1  | 20      | €34.95 |
| 20100032 | T831  | MK2 3002 ALU SPOOL | M/MM 115/0.20 | *         | *        | *      | 1  | 20      | €14.95 |
| 20100033 | T831  | MK2 4002 ALU SPOOL | M/MM 200/0.22 | *         | *        | *      | 1  | 20      | €14.95 |
| 20100034 | T831  | MK2 5002 ALU SPOOL | M/MM 200/0.25 | *         | *        | *      | 1  | 20      | €14.95 |



REELS



# IMPAX

- › Gear ratio 5.2:1
- › Shallow aluminium spool
- › High strength graphite body and balanced rotor construction
- › S-curve oscillation system
- › Twin spring-loaded round metal line-clips
- › Micro adjustable front drag
- › Sealed one-way clutch system
- › Oversized hollow bail wire
- › Twist-free line roller
- › Ambidextrous aluminium CNC handle



## IMPAX 3000, 4000, 5000

The Impax series of reels truly do make an impact! Offering superb value for money and featuring 4+1 ball bearings and an S-curve cross winding oscillation system, for a perfect line-lay of both mono and braid. Available in three sizes, 3000, 4000 and 5000, these reels cover about all modern coarse fishing techniques, including carp feeder and pellet waggler fishing on commercials.

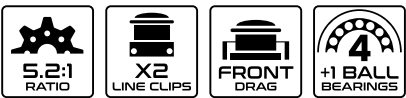

| CODE     | TREF  | DESCRIPTION          | CAPACITY       | DRAG      | RETRIEVE | WEIGHT | SU | CTN QTY | RRP    |
|----------|-------|----------------------|----------------|-----------|----------|--------|----|---------|--------|
| 20100005 | T2775 | IMPAX 3000           | M/MM 120/0.205 | 6KG/13LB  | 76CM     | 254G   | 1  | 20      | €49.95 |
| 20100006 | T2775 | IMPAX 4000           | M/MM 150/0.205 | 10KG/22LB | 77CM     | 326G   | 1  | 20      | €49.95 |
| 20100007 | T2775 | IMPAX 5000           | M/MM 130/0.18  | 10KG/22LB | 83CM     | 344G   | 1  | 20      | €49.95 |
| 20100008 | T831  | IMPAX 3000 ALU SPOOL | M/MM 120/0.205 | *         | *        | 59G    | 1  | 20      | €14.95 |
| 20100009 | T831  | IMPAX 4000 ALU SPOOL | M/MM 150/0.205 | *         | *        | 79G    | 1  | 20      | €14.95 |
| 20100010 | T831  | IMPAX 5000 ALU SPOOL | M/MM 130/0.18  | *         | *        | 80G    | 1  | 20      | €14.95 |



# IMPAX



REELS

NYTRO

- > Gear ratio 4.7:1
- > 5+1 ball bearing system
- > Medium-deep aluminium long-cast feeder spool
- > High strength graphite body and balanced rotor construction
- > Reliable line-guard system
- > Cross-winding wormshaft oscillation system
- > Two round metal line clips
- > Quick-drag front drag system
- > One-way clutch system
- > Oversized bail wire
- > Teardrop design, twist-free line roller
- > Comfortable rubber T-grip handle



## IMPAX LONG CAST 5500



With the new Impax Long Cast 5500 we know we have something special. When you thought our value for money proposition could not get any better, wait until you see this new feeder reel. It comes with a cross-winding wormshaft oscillation system and a long cast spool, protected by a line-guard system. Besides a very stylish design of mat black with some Nytro red accents, the Impax Long Cast 5500 also features a quick-drag with oversized front-drag knob and multi-disc drag system. In addition it features two oversized metal line clips, a teardrop shaped line roller and heavy-duty bail arm wire, preventing deformation. The handle easily folds away for transportation.



| CODE    | TREF  | DESCRIPTION                    | CAPACITY      | DRAG             | RETRIEVE | WEIGHT | SU | CTN QTY | RRP    |
|---------|-------|--------------------------------|---------------|------------------|----------|--------|----|---------|--------|
| 2010053 | T3331 | IMPAX LONG CAST 5500           | M/MM 230/0.35 | 18-20KG/40-44LBS | 94CM     | 416    | 1  | 20      | €59.95 |
| 2010054 | T831  | IMPAX LONG CAST 5500 ALU SPOOL | M/MM 230/0.35 | *                | *        | *      | 1  |         | €14.95 |



REELS



# SOLUS

- › Gear ratio 5.2:1
- › Micro-adjustable, multi-disc front drag
- › Independent free spool rear drag
- › High-strength lightweight graphite body and balanced rotor construction
- › Medium-shallow aluminium feeder spool for mono and braid
- › Line capacity: 150m/0.26mm
- › 5+1 ball bearings
- › S-curve crosswind oscillation system
- › Two round metal line-clips
- › One-way clutch system
- › Oversized hollow bail wire
- › Twist-free, extra smooth titanium coated line roller
- › Compact, ambidextrous aluminium CNC handle
- › Comfortable T-bar handle grip



## SOLUS FREERUNNER 4000

The Solus Freerunner 4000 is a free spool style reel designed for feeder fishing which offers superb value for money. The 4000-size suits most feeder and traditional carp fishing conditions.

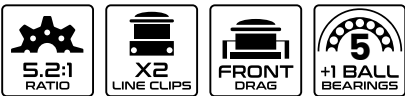

| CODE     | TREF  | DESCRIPTION               | CAPACITY      | DRAG     | RETRIEVE | WEIGHT | SU | CTN QTY | RRP    |
|----------|-------|---------------------------|---------------|----------|----------|--------|----|---------|--------|
| 20100035 | T2775 | FREERUNNER 4000           | M/MM 150/0.26 | 6KG/13LB | 85CM     | 360G   | 1  | 20      | €49.95 |
| 20100036 | T831  | FREERUNNER 4000 ALU SPOOL | M/MM 160/0.28 | *        | *        | 81G    | 1  | 50      | €14.95 |



REELS



# SOLUS

- > Gear ratio 4.7:1
- > 5+1 Ball bearings
- > Multi-disc quick-drag system
- > Medium-shallow aluminium feeder spool for mono and braid
- > Line capacity: 130m/0.25mm
- > Recuperation: 84cm/turn
- > High-strength lightweight graphite body and balanced rotor construction
- > S-curve crosswind oscillation system
- > Two round metal line-clips
- > Sealed one-way clutch system
- > Oversized hollow bail wire
- > Twist-free, extra smooth titanium coated line roller
- > Compact, ambidextrous aluminium CNC handle
- > Comfortable T-bar handle grip



## SOLUS SUPER FEEDER 5500

The Solus Super Feeder 5500 is a robust feeder reel designed for medium to long distance casting. The lightweight S-curve cross-winding oscillation system inside the reel offers a multitude of advantages. It keeps the reel surprisingly light, allows for perfect spooling of both braid and mono on the medium-shallow feeder spool and it is exceptionally strong to withstand rugged handling. The Solus Super Feeder features a quick-drag system for rapid and precise control when playing bigger fish. A very functional reel for most allround feeder fishing conditions on natural venues.



| CODE     | TREF  | DESCRIPTION                 | CAPACITY      | DRAG     | RETRIEVE | WEIGHT | SU | CTN QTY | RRP    |
|----------|-------|-----------------------------|---------------|----------|----------|--------|----|---------|--------|
| 20100037 | T4164 | SUPER FEEDER 5500           | M/MM 130/0.25 | 8KG/18LB | 84CM     | 393G   | 1  | 20      | €74.95 |
| 20100038 | T1108 | SUPER FEEDER ALU SPOOL 5500 | M/MM 130/0.25 | *        | *        | 81G    | 1  | 50      | €19.95 |



REELS



# SOLUS

- › Long-distance reel design
- › Gear ratio 4.7:1
- › 5+1 Ball bearings
- › Multi-disc quick-drag system
- › Line-guard system
- › Medium-shallow aluminium feeder spool for mono and braid
- › Line capacity: 190m/0.25mm
- › Recuperation: 93cm/turn
- › High-strength lightweight graphite body and balanced rotor construction
- › S-curve crosswind oscillation system
- › Two round metal line-clips
- › Sealed one-way clutch system
- › Oversized bail wire
- › Twist-free, extra smooth titanium coated line roller
- › Compact, ambidextrous aluminium CNC handle
- › Comfortable T-bar handle grip



## SOLUS DISTANCE FEEDER 6500

The Solus Distance Feeder 6500 is a robust, big capacity feeder reel designed for most medium to long distance casting. For safety purposes, the Solus Distance Feeder features a line-guard system to prevent the line from tangling underneath the spool. The lightweight S-curve cross-winding oscillation system inside the reel offers a multitude of advantages. It keeps the reel surprisingly light, allows for perfect spooling of both braid and mono on the medium-shallow feeder spool and it is exceptionally strong to withstand rugged handling. The Solus Distance Feeder features a quick-drag system for rapid and precise control when playing bigger fish.



| CODE     | TREF  | DESCRIPTION                    | CAPACITY      | DRAG     | RETRIEVE | WEIGHT | SU | CTN QTY | RRP    |
|----------|-------|--------------------------------|---------------|----------|----------|--------|----|---------|--------|
| 20100039 | T4442 | DISTANCE FEEDER 6500           | M/MM 190/0.25 | 8KG/18LB | 93CM     | 427G   | 1  | 20      | €79.95 |
| 20100040 | TT108 | DISTANCE FEEDER ALU SPOOL 6500 | M/MM 190/0.25 | *        | *        | 92G    | 1  | 50      | €19.95 |



REELS

NYTRO

# STARKX

- > Gear ratio 5.2:1
- > Wormshaft oscillation system
- > Shallow aluminium long-nose spool
- > High-strength carbon body and rotor construction
- > Line-guard system
- > Two round metal line-clips
- > Multi-washer micro adjustable front drag
- > One-way clutch system
- > Strong main shaft
- > Oversized bail wire
- > Tapered bail arm holder
- > Twist-free line roller
- > Ambidextrous, aluminium handle featuring a T-bar handle grip

## STARKX

### CARBON LONG CAST 4500, 5500, 6500

The NyTRO StarkX Carbon Long Cast reels feature a wormshaft system to perfectly distribute mono or braid on to the extra-long-nose aluminium spool. They are ideal reels for effortless long-distance casting. The line-guard system prevents any tangling of the line. This model is available in three sizes, 4500, 5500 and 6500 to cover most, if not all, distance casting conditions. The 7+1 stainless steel ball bearings allow for an extremely smooth operation. They are ideal casting machines and compliment rods such as the StarkX Big River and Method or the Aryzon Continental and Power Feeder series.



| CODE     | TREF  | DESCRIPTION                  | CAPACITY      | DRAG     | RETRIEVE | WEIGHT | SU | CTN QTY | RRP    |
|----------|-------|------------------------------|---------------|----------|----------|--------|----|---------|--------|
| 20100041 | T3886 | STARKX CARBON LONG CAST 4500 | M/MM 170/0.20 | 8KG/18LB | 87CM     | 420G   | 1  | 10      | €69.95 |
| 20100042 | T4164 | STARKX CARBON LONG CAST 5500 | M/MM 155/0.22 | 8KG/18LB | 95CM     | 435G   | 1  | 10      | €74.95 |
| 20100043 | T4442 | STARKX CARBON LONG CAST 6500 | M/MM 135/0.25 | 8KG/18LB | 103CM    | 454G   | 1  | 10      | €79.95 |
| 20100044 | T886  | STARKX CLC 4500 ALU SPOOL    | M/MM 170/0.20 | *        | *        | 82G    | 1  | 50      | €15.95 |
| 20100045 | T886  | STARKX CLC 5500 ALU SPOOL    | M/MM 155/0.22 | *        | *        | 87G    | 1  | 50      | €15.95 |
| 20100046 | T886  | STARKX CLC 6500 ALU SPOOL    | M/MM 135/0.25 | *        | *        | 98G    | 1  | 50      | €15.95 |



REELS



# ARYZON

- › Gear ratio 5.2:1
- › Shallow aluminium long-cast spool
- › High strength graphite body and rotor construction
- › S-curve oscillation system
- › Spring-loaded round metal line-clips
- › Screw-in handle
- › Multi-disc adjustable front drag
- › Sealed one-way clutch system
- › Oversized hollow bail wire
- › Tapered bail arm holder
- › Twist-free extra smooth line roller
- › Compact ambidextrous aluminium CNC handle
- › Comfortable T-bar handle grip



## ARYZON 3000, 4000 & 5000 REELS

Finished in glossy black with red accents, the Aryzon is a series of stunning looking reels, built for performance. The Aryzon series is available in three sizes, 3000, 4000 and 5000. With a 6+1 ball bearing system they perform extremely well in all manner of situations. They offer a silky-smooth retrieve and good line-lay for both mono and braid. Featuring a finely adjustable, multi-disc drag system on the spool. Ideal when matched with Aryzon commercial rods.



| CODE     | TREF  | DESCRIPTION           | CAPACITY      | DRAG     | RETRIEVE | WEIGHT | SU | CTN QTY | RRP    |
|----------|-------|-----------------------|---------------|----------|----------|--------|----|---------|--------|
| 20100023 | T4442 | ARYZON 3000           | M/MM 135/0.23 | 6KG/13LB | 95CM     | 262G   | 1  | 10      | €79.95 |
| 20100024 | T4719 | ARYZON 4000           | M/MM 130/0.26 | 7KG/15LB | 103CM    | 298G   | 1  | 10      | €84.95 |
| 20100025 | T4997 | ARYZON 5000           | M/MM 150/0.26 | 8KG/18LB | 111CM    | 405G   | 1  | 10      | €89.95 |
| 20100026 | T1108 | ARYZON 3000 ALU SPOOL | M/MM 135/0.23 | *        | *        | 61G    | 1  | 50      | €19.95 |
| 20100027 | T1108 | ARYZON 4000 ALU SPOOL | M/MM 130/0.26 | *        | *        | 78G    | 1  | 50      | €19.95 |
| 20100028 | T1108 | ARYZON 5000 ALU SPOOL | M/MM 150/0.26 | *        | *        | 117G   | 1  | 50      | €19.95 |

# ARYZON



REELS

NYTRO

- › Gear ratio 4.7:1
- › Wormshaft oscillation system
- › Shallow aluminium long-cast spool
- › High strength graphite body and rotor construction
- › Floating rotor line-guard system
- › Twin spring-loaded round metal line-clips
- › Multi-washer micro adjustable front drag
- › Sealed one-way clutch system
- › Quick-torque drag system
- › Strong main shaft
- › Zinc alloy drive gear
- › Precision machined brass pinion gear
- › Large diameter aluminium bail wire
- › Tapered bail arm holder
- › Twist-free line roller
- › Ambidextrous aluminium CNC handle featuring a rubber handle grip



## ARYZON LONG CAST 5000

The Aryzon Long Cast is a robust, large capacity feeder reel for long range casting. The wormshaft oscillation offers the perfect line-lay and the floating rotor line guard helps to prevent any tangles. Surprisingly light for its size this 6+1 ball bearing reel retrieves close to 1m of line per turn. Two high impact captive line clips help with your accuracy and the quick torque drag system keeps you in control of a big fish. The Aryzon Long Cast combines really well with the Aryzon Continental and Starkx Big River or Method rods.



| CODE     | TREF  | DESCRIPTION              | CAPACITY      | DRAG      | RETRIEVE | WEIGHT | SU | CTN QTY | RRP    |
|----------|-------|--------------------------|---------------|-----------|----------|--------|----|---------|--------|
| 20100021 | T4442 | ARYZON 5000 LONG CAST    | M/MM 210/0.28 | 13KG/29LB | 94CM     | 440G   | 1  | 10      | €79.95 |
| 20100022 | T1108 | ARYZON 5000 LC ALU SPOOL | M/MM 210/0.28 | *         | *        | 96G    | 1  | 50      | €19.95 |



REELS



# ARYZON

- > Gear ratio 4.7:1
- > Filled with 200m Aryzon Bait-up Hi-Viz Lime Green Braid 22lb/0.16mm
- > 5+1 Ball bearing system
- > Medium-deep aluminium long-cast feeder spool
- > High strength graphite body and balanced rotor construction
- > Reliable line-guard system
- > Cross-winding wormshaft oscillation system
- > Two round metal line clips
- > Quick-drag front drag system
- > One-way clutch system
- > Oversized bail wire
- > Teardrop design, twist-free line roller
- > Ambidextrous aluminium screw-in CNC handle
- > Comfortable rubber T-grip handle



## ARYZON BAIT-UP 5000

NEW

We have designed our Aryzon Bait-Up 5000 reel to hold 200m of Aryzon Bait-up Braid and that is how we supply it, already spooled and ready to use! It is powerful enough to cast big bait-up feeders over medium to long range distances, effortlessly. Besides a very stylish design of gunsmoke with black and some Nytro red accents, the Aryzon Bait-up reel also features a quick-drag with oversized front-drag knob and multi-disc drag system. Other features include two oversized metal line clips, a teardrop shaped line roller and heavy-duty bail arm wire, preventing deformation. The screw-in handle eliminated play on the handle and easily folds away for transportation.

Designed to be compatible with the Aryzon Bait-up Rod and Braid on pages: 15 and 45.

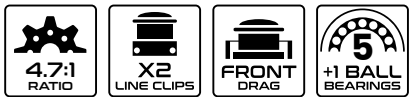

COMES FULLY LOADED WITH 200M OF ARYZON BAIT UP BRAID



| CODE    | TREF  | DESCRIPTION                       | CAPACITY      | DRAG             | RETRIEVE | WEIGHT | SU | CTN QTY | RRP    |
|---------|-------|-----------------------------------|---------------|------------------|----------|--------|----|---------|--------|
| 2010061 | T4442 | ARYZON BAIT-UP 5000 (200M 0.16MM) | M/MM 210/0.28 | 18-20KG/40-44LBS | 94CM     | 420G   | 1  | 20      | €79.95 |
| 2010062 | T1108 | ARYZON BAIT-UP 5000 ALU SPOOL     | M/MM 210/0.28 | *                | *        | 92G    | 1  | *       | €19.95 |



# MARVELIST



REELS



- › Gear ratio 4.9:1
- › 6+1 Ball bearings
- › Medium-shallow aluminium feeder pop-off spool for mono and braid
- › Spare spool included
- › High-strength aluminium body
- › Graphite balanced rotor construction
- › S-curve crosswind oscillation system
- › Two oversized round metal line-clips
- › Micro-adjustable, multi-disc front drag
- › Sealed one-way clutch system
- › Oversized bail wire
- › Twist-free line roller
- › Compact, screw-in machined aluminium handle
- › Ambidextrous
- › Comfortable soft-touch T-bar handle grip



## MARVELIST POWER FEEDER SERIES



Designed in close collaboration with former World Champion Tommy Pickering, these Marvelist Power Feeder reels are top choice for the angler that demands the absolute best and will cover most, if not all, feeder fishing situations.

Whether fishing commercials or natural venues, still water or fast flowing rivers, the Marvelist Power Feeder reels are up to the job. We have designed these reels to saltwater standards, which means the aluminium body offers maximum strength and protection to the internal mechanism, even when the fighting gets hard. The solid stainless steel main shaft and heavy-duty internal structure of the Marvelist reels make them true fighting machines.

For 2025 we have launched one size bigger, the Marvelist 6000 Power Feeder. A reel that is for fishing bigger venues holding bigger fish and for casting longer distances.



| CODE     | TREF  | DESCRIPTION                           | CAPACITY                 | DRAG      | RETRIEVE | WEIGHT | SU | CTN QTY | RRP     |
|----------|-------|---------------------------------------|--------------------------|-----------|----------|--------|----|---------|---------|
| 20100047 | T7219 | MARVELIST POWER FEEDER 4000           | M/MM 150/0.26            | 10KG/22LB | 78CM     | 354G   | 1  | 10      | €129.95 |
| 20100048 | T7775 | MARVELIST POWER FEEDER 5000           | M/MM 150/0.28            | 12KG/26LB | 85CM     | 397G   | 1  | 10      | €139.95 |
| 20100049 | T8331 | MARVELIST POWER FEEDER 6000           | <b>NEW</b> M/MM 300/0.28 | 12KG/26LB | 85CM     | 442G   | 1  | 10      | €149.95 |
| 20100050 | T1942 | MARVELIST POWER FEEDER 4000 ALU SPOOL | M/MM 150/0.26            | *         | *        | 73G    | 1  | 50      | €34.95  |
| 20100051 | T1942 | MARVELIST POWER FEEDER 5000 ALU SPOOL | M/MM 150/0.28            | *         | *        | 84G    | 1  | 50      | €34.95  |
| 20100051 | T1942 | MARVELIST POWER FEEDER 6000 ALU SPOOL | <b>NEW</b> M/MM 300/0.28 | *         | *        | 98G    | 1  | 20      | €34.95  |



150M  
165YDS

0.23MM  
9.8  
4.1kg

**NYTRO**

**SUBLIME**  
**SINKING FEEDER**  
**MONO**

FIRST RATE REEL LINE / SUPERB SHOCK LEADER

FAST SINKING / HIGH KNOT STRENGTH

EXCEPTIONAL ABRASION RESISTANCE

 NYLON FEEDER COULANT

AMIR



LINE

# SUBLIME



## SUBLIME X8 SINKING BRAID



This high-quality, 8-strand, fast sinking braid, has been specifically designed for feeder fishing. Featuring a sinking core, no-stretch X8 round braid, smooth surface and high tensile strength. These are just some of the key characteristics that make this braid ideal for feeder fishing. Available in three diameters on 150m spools.

- > High quality sinking braided main line
- > Designed for feeder fishing
- > 8-strand round braided precision diameter
- > Superb knot strength
- > No stretch for maximum bite registration
- > Abrasion resistant smooth coating
- > Available in 0.08mm, 0.10mm, 0.12mm
- > Supplied on 150-meter spools

| CODE     | TREF  | DESCRIPTION                    | DIAMETER | BREAKING STRAIN | SU | CTN QTY | RRP    |
|----------|-------|--------------------------------|----------|-----------------|----|---------|--------|
| 20600001 | T1664 | X8 SINKING FEEDER BRAID 0.08MM | 0.08MM   | 8LB/3.6KG       | 5  | 100     | €29.95 |
| 20600002 | T1664 | X8 SINKING FEEDER BRAID 0.10MM | 0.10MM   | 10LB/4.5KG      | 5  | 100     | €29.95 |
| 20600003 | T1664 | X8 SINKING FEEDER BRAID 0.12MM | 0.12MM   | 12LB/5.5KG      | 5  | 100     | €29.95 |



## SUBLIME SINKING MONO

The Nytro Sublime Sinking Feeder Mono has been designed for feeder fishing. As the line sinks the transparent deep bronze color disappears against most backgrounds. It is strong, yet supple, so it casts really well and it offers a high knot strength. Ideal as a reel line and just as good when used as a shock leader, as it stretches well and hugs the bottom.

- > High quality sinking monofilament
- > Designed for feeder fishing
- > Precision diameter
- > Strong, supple and superb knot strength
- > Abrasion resistant
- > Available in six popular diameters
- > Supplied on 150-meter spools

| CODE     | TREF | DESCRIPTION   | DIAMETER | BREAKING STRAIN | SU | CTN QTY | RRP   |
|----------|------|---|----------|-----------------|----|---------|-------|
| 20600010 | T417 | SINKING FEEDER MONO 0.16                                    | 0.16MM   | 4LB/1.8KG       | 5  | 100     | €7.50 |
| 20600011 | T417 | SINKING FEEDER MONO 0.18                                    | 0.18MM   | 5LB/2.3KG       | 5  | 100     | €7.50 |
| 20600012 | T417 | SINKING FEEDER MONO 0.20                                    | 0.20MM   | 7LB/3.2KG       | 5  | 100     | €7.50 |
| 20600013 | T417 | SINKING FEEDER MONO 0.23                                    | 0.23MM   | 9LB/4.1KG       | 5  | 100     | €7.50 |
| 20600014 | T417 | SINKING FEEDER MONO 0.26                                    | 0.26MM   | 11LB/5.0KG      | 5  | 100     | €7.50 |
| 20600015 | T417 | SINKING FEEDER MONO 0.28                                    | 0.28MM   | 13LB/5.9KG      | 5  | 100     | €7.50 |
| 20600030 | T417 | SINKING FEEDER MONO 0.30 <span style="color:red">NEW</span> | 0.30MM   | 17LB/7.7KG      | 5  | 100     | €7.50 |
| 20600031 | T417 | SINKING FEEDER MONO 0.33 <span style="color:red">NEW</span> | 0.33MM   | 19LB/8.6KG      | 5  | 100     | €7.50 |





LINE



# SUBLIME

## POWER RIG MONO

Our crystal-clear, Nytro Sublime Power Rig Mono is a very durable monofilament and is ideal for feeder rigs. It is a high-tech monofilament. It combines strength with a balanced stretch to absorb the powerful lunges of bigger fish.

- > High-tech monofilament
- > Durable
- > Accurate diameter
- > Superb knot strength
- > Supple with balanced stretch
- > Abrasion resistant
- > Available in nine popular diameters
- > Supplied on 100-meter spools

| CODE     | TREF | DESCRIPTION         | DIAMETER | BREAKING STRAIN | SU | CTN QTY | RRP   |
|----------|------|---------------------|----------|-----------------|----|---------|-------|
| 20600020 | T277 | POWER RIG MONO 0.09 | 0.09MM   | 1.7LB/0.8KG     | 5  | 300     | €4.99 |
| 20600021 | T277 | POWER RIG MONO 0.11 | 0.11MM   | 2.2LB/1.0KG     | 5  | 300     | €4.99 |
| 20600022 | T277 | POWER RIG MONO 0.13 | 0.13MM   | 3.2LB/1.5KG     | 5  | 300     | €4.99 |
| 20600023 | T277 | POWER RIG MONO 0.15 | 0.15MM   | 4.1LB/1.9KG     | 5  | 300     | €4.99 |
| 20600024 | T277 | POWER RIG MONO 0.17 | 0.17MM   | 5.2LB/2.4KG     | 5  | 300     | €4.99 |
| 20600025 | T277 | POWER RIG MONO 0.19 | 0.19MM   | 6.2LB/2.8KG     | 5  | 300     | €4.99 |
| 20600026 | T277 | POWER RIG MONO 0.21 | 0.21MM   | 7.7LB/3.5KG     | 5  | 300     | €4.99 |
| 20600027 | T277 | POWER RIG MONO 0.23 | 0.23MM   | 9.6LB/4.4KG     | 5  | 300     | €4.99 |
| 20600028 | T277 | POWER RIG MONO 0.25 | 0.25MM   | 12.0LB/5.5KG    | 5  | 300     | €4.99 |



# SUBLIME

## POWER RIG FLUORO



NyTRO's Sublime Power Rig Fluoro is the perfect fluorocarbon line for tying shock leaders and hooklengths. During its design, we focused on enhancing knot strength, a feature typically lacking in fluorocarbon lines. With the new Sublime Power Rig Fluoro range, we've successfully achieved this goal! Our lines enable stronger knots and with a few stretches between your thumb and index finger, it will lose memory and straighten naturally when taken off the spool.

- > Superior knot strength
- > Low visibility
- > Abrasion resistance
- > High density
- > Minimal stretch
- > UV resistance
- > Supplied on 50m spools

| CODE     | TREF | DESCRIPTION                 | DIAMETER | BREAKING STRAIN | SU | CTN QTY | RRP   |
|----------|------|-----------------------------|----------|-----------------|----|---------|-------|
| 20600032 | T553 | POWER RIG FLUORO 50M 0.13MM | 0.13MM   | 3.0LB/1.4KG     | 5  | 200     | €9.95 |
| 20600033 | T553 | POWER RIG FLUORO 50M 0.15MM | 0.15MM   | 3.7LB/1.7KG     | 5  | 200     | €9.95 |
| 20600034 | T553 | POWER RIG FLUORO 50M 0.17MM | 0.17MM   | 4.4LB/2.0KG     | 5  | 200     | €9.95 |
| 20600035 | T553 | POWER RIG FLUORO 50M 0.19MM | 0.19MM   | 5.0LB/2.3KG     | 5  | 200     | €9.95 |
| 20600036 | T553 | POWER RIG FLUORO 50M 0.21MM | 0.21MM   | 7.5LB/3.4KG     | 5  | 200     | €9.95 |
| 20600037 | T553 | POWER RIG FLUORO 50M 0.23MM | 0.23MM   | 8.4LB/3.8KG     | 5  | 200     | €9.95 |
| 20600038 | T553 | POWER RIG FLUORO 50M 0.26MM | 0.26MM   | 10.0LB/4.5KG    | 5  | 200     | €9.95 |
| 20600039 | T553 | POWER RIG FLUORO 50M 0.29MM | 0.29MM   | 12.5LB/5.7KG    | 5  | 200     | €9.95 |



# ARYZON

## HI-VIZ FEEDER SPOD BRAID



Our high-quality, Aryzon Hi-Viz Bait-up X8-strand, super smooth, round braid, has been designed for use with baiting up reels. Featuring no-stretch, for more accurate casting as well as emptying your bait-up feeder on a simple pull back. It has a smooth medium-pitch surface, high tensile strength, superb knot strength and of course is abrasion resistant. The no-stretch function of our Aryzon Hi-Viz Bait-up braid results in improved power transfer, where more power is directly transmitted from the rod to the bait-up feeder. This efficient power transfer enables the angler to cast heavier loads further, which is essential for reaching distant baiting areas.

- > High quality braided main line
- > Designed for baiting-up
- > 8-strand round braided precision diameter
- > Superb knot strength
- > No stretch for enhanced casting accuracy
- > Efficient power transfer
- > Abrasion resistant smooth coating
- > Available in 0.16mm
- > Supplied on 200-meter spools

| CODE     | TREF  | DESCRIPTION              | DIAMETER | BREAKING STRAIN | SU | CTN QTY | RRP    |
|----------|-------|--------------------------|----------|-----------------|----|---------|--------|
| 20600041 | T1108 | HIVIZ BAIT-UP BRAID 200M | 0.16MM   | 10LB/4.5KG      | 5  | 200     | €19.95 |





STENZ



KEEP NETS

NYTRO

## SPACE CREATOR COMMERCIAL CARP KEEPNETS

The ultimate solution to net limits on commercial fisheries. The reversed rectangular top ring creates more space, which is ideal for where strict weight limits per net is practiced on modern-day commercial fisheries. These nets are manufactured using ultra durable, carp-friendly mesh.

- > Reversed rectangular shape, 50x40cm
- > Strong plastic rings
- > Durable carp-friendly mesh
- > Two strong webbing pull-through straps inside for weighing-in
- > Equipped with double, universal screw thread
- > Robust pressure-lock adjustable tilt system
- > Available in 2.5m and 3m lengths
- > Particularly stylish design
- > Provides a professional look

| CODE     | TREF  | DESCRIPTION                                | SU | CTN QTY | RRP    |
|----------|-------|--|----|---------|--------|
| 20900001 | T3331 | KEEPNET SPACE CREATOR COMMERCIAL CARP 2500 | 1  | 5       | €59.95 |
| 20900002 | T3608 | KEEPNET SPACE CREATOR COMMERCIAL CARP 3000 | 1  | 5       | €64.95 |



## COMMERCIAL CARP KEEPNETS

Extra strong rectangular keepnet. Manufactured using very durable, carp-friendly, densely woven mesh fabric that dries very quickly. The net features a pressure-lock adjustable tilt system. The shorter lengths are ideal for commercial fisheries. The longer lengths are suited to natural venues where carp are one of the target species.

- > Rectangular shape, 50x40cm
- > Durable, densely woven, quick-dry, carp-friendly mesh
- > Two strong pull-through webbing straps inside for weighing-in
- > Equipped with double, universal screw thread
- > Robust pressure-lock adjustable tilt system
- > Available in 2,5m, 3m and 4m lengths
- > Particularly stylish design
- > Provides a professional look

| CODE     | TREF  | DESCRIPTION            | SU | CTN QTY | RRP    |
|----------|-------|------------------------|----|---------|--------|
| 20900003 | T3331 | KEEPNET CARP MESH 2500 | 1  | 5       | €59.95 |
| 20900004 | T3608 | KEEPNET CARP MESH 3000 | 1  | 5       | €64.95 |
| 20900005 | T3886 | KEEPNET CARP MESH 4000 | 1  | 5       | €64.95 |





# COMMERCIAL CARP KEEPNETS



These 2.5m keepnets are the perfect choice for all anglers on commercial fisheries. Coming in a value pack of three nets, they are ideal for where strict weight limits per net are practiced on modern-day fisheries. Manufactured using ultra durable, carp-friendly mesh and featuring a strong tilt-system.

- > Rectangular shape, 50x40cm
- > Durable, densely woven, quick-dry, carp-friendly mesh
- > Two strong pull-through webbing straps inside for weighing-in
- > Equipped with double, universal screw thread
- > Robust adjustable tilt system
- > Lengths: 2.5m, 3m and 4m
- > Stylish design
- > Provides a professional look on the bank

| CODE     | TREF  | DESCRIPTION                                | SU  | CTN QTY | RRP     |         |
|----------|-------|--|-----|---------|---------|---------|
| 20900028 | T6108 | COMMERCIAL CARP NET 2.5M VALUE PACK 3 NETS | 1   | 3       | €109.95 |         |
| 20900034 | T7775 | COMMERCIAL CARP NET 3M VALUE PACK 3 NETS   | NEW | 1       | 5       | €139.95 |
| 20900035 | T8886 | COMMERCIAL CARP NET 4M VALUE PACK 3 NETS   | NEW | 1       | 5       | €159.95 |



# SILVERFISH KEEPNETS

Extra strong rectangular keepnet with an oversized top ring. Manufactured using durable 5mm round, quick-dry, garment mesh fabric. The keepnet features a pressure-lock, finely adjustable tilt system.

- > Rectangular shape, 40x45cm with an oversized 50x40cm top ring
- > Durable quick-dry 5mm round mesh
- > Two strong pull through webbing straps inside for weighing-in
- > Equipped with double, universal screw thread
- > Robust pressure-lock adjustable tilt system
- > Available in 3m, 3.5m and 4m lengths
- > Particularly stylish design
- > Provides a professional look

| CODE     | TREF  | DESCRIPTION                              | SU | CTN QTY | RRP    |
|----------|-------|--|----|---------|--------|
| 20900006 | T3331 | KEEPNET LAKE & CANAL QUICK DRY MESH 3000 | 1  | 5       | €59.95 |
| 20900007 | T3608 | KEEPNET LAKE & CANAL QUICK DRY MESH 3500 | 1  | 5       | €64.95 |
| 20900008 | T3886 | KEEPNET LAKE & CANAL QUICK DRY MESH 4000 | 1  | 5       | €69.95 |



# SILVERFISH PRO KEEPNETS

This Nytro Silverfish Pro comes in two different sizes, 3m and 4m which makes it ideal for fishing both commercials and natural venues. On the bankside of the net we have reinforced the fabric on the corners of the rings to prevent any damage when rubbing against sticks, stones or other debris. The aluminium bottom ring is protected on all corners. The aluminium rings at the bottom allow the net to sink faster in deeper water. The top to second ring features a nylon fabric with Nytro logo to prevent the hook from tangling in the net. There are two strong webbing pull-through handles inside to make weighing-in very easy. The keepnet features a pressure-lock, finely adjustable tilt system.

- > Rectangular shape, 40x45cm with an oversized 50x40cm top ring
- > Top ring with branded nylon fabric
- > Last three rings in aluminium protect against distortion
- > Fast sink
- > Durable quick-dry 5mm round mesh
- > Two strong webbing straps inside for weighing-in
- > Protected edges against wear and tear
- > Equipped with double, universal screw thread
- > Robust pressure-lock adjustable tilt system
- > Available in 3m and 4m lengths
- > Particularly stylish design
- > Provides a professional look

| CODE     | TREF  | DESCRIPTION                | SU | CTN QTY | RRP    |
|----------|-------|----------------------------|----|---------|--------|
| 20900026 | T4164 | SILVERFISH PRO KEEPNET 300 | 1  | 5       | €74.95 |
| 20900027 | T4719 | SILVERFISH PRO KEEPNET 400 | 1  | 5       | €84.95 |







NYTRO  
performance first

NYTRO

NYTRO

NYTRO

GORE-TEX

ryu

NEW  
ZEALAND

SPACE CREATOR  
COMMERCIAL CARP

NYTRO  
performance

SPACE CREATOR  
COMMERCIAL CARP

NYTRO  
performance



## QUICK-DRY HAIR MESH

This 2.5mm quick-dry fine hexamesh net is ideal when fishing with hair rigs. The fine mesh will stop the hair rig tangling when landing and unhooking fish.

- > Durable lifting-assist nylon spreader block for safe and easy fish handling
- > Sturdy red aluminium frame
- > Quick-dry
- > Black and grey 2.5mm hexamesh hair mesh fabric
- > Available in three sizes (16"/40cm, 18"/45cm and 20"/50cm)



| CODE     | TREF  | DESCRIPTION                              | FRAME WIDTH | FRAME HEIGHT | NET DEPTH | SU | CTN QTY | RRP    |
|----------|-------|--|-------------|--------------|-----------|----|---------|--------|
| 20900010 | T997  | SPOON NET QUICK-DRY HAIR MESH 16" (40CM) | 40CM        | 30CM         | 20CM      | 1  | 25      | €17.95 |
| 20900011 | T1053 | SPOON NET QUICK-DRY HAIR MESH 18" (45CM) | 45CM        | 35CM         | 25CM      | 1  | 25      | €18.95 |
| 20900012 | T1108 | SPOON NET QUICK-DRY HAIR MESH 20" (50CM) | 50CM        | 40CM         | 30CM      | 1  | 25      | €19.95 |

## QUICK-DRY BIG FISH

These nets feature quick-dry 8.5mm lightweight fabric, making netting fish with longer net handles much easier. The fabric does not absorb water and the 8.5mm mesh flows through the water with ease, the ideal net for rivers. The special fabric is super-soft avoiding any damage to fish. Water and slime are not absorbed and these nets dry exceptionally fast and barely smell after use.

- > Durable lifting-assist nylon spreader block for safe and easy fish landing
- > Sturdy red aluminum frame
- > Black 8.5mm quick-dry and smell-free fabric
- > Available in three sizes (18"/45cm, 20"/50cm and 22"/55cm)



| CODE     | TREF  | DESCRIPTION                             | FRAME WIDTH | FRAME HEIGHT | NET DEPTH | SU | CTN QTY | RRP    |
|----------|-------|---|-------------|--------------|-----------|----|---------|--------|
| 20900020 | T1219 | SPOON NET QUICK-DRY BIG FISH 18" (40CM) | 40CM        | 45CM         | 30CM      | 1  | 25      | €21.95 |
| 20900021 | T1275 | SPOON NET QUICK-DRY BIG FISH 20" (45CM) | 45CM        | 40CM         | 33CM      | 1  | 25      | €22.95 |
| 20900022 | T1331 | SPOON NET QUICK-DRY BIG FISH 22" (50CM) | 50CM        | 45CM         | 36CM      | 1  | 25      | €23.95 |

## LATEX HAIR MESH

This 2.5mm quick-dry, latex dipped fine hexamesh net, is ideal when fishing with hair rigs. The softness of the material avoids any damage to fish. The latex dip makes this net even more durable and longer lasting. It also features a durable lift-assist spreader block allowing bigger fish to be lifted with ease.

- > Durable lifting-assist nylon spreader block for safe and easy fish landing
- > Sturdy red aluminum frame
- > Quick-dry
- > Black and red 2.5mm latex dipped hexamesh fabric
- > Available in three sizes (16"/40cm, 18"/45cm and 20"/50cm)



| CODE     | TREF  | DESCRIPTION                          | FRAME WIDTH | FRAME HEIGHT | NET DEPTH | SU | CTN QTY | RRP    |
|----------|-------|--------------------------------------|-------------|--------------|-----------|----|---------|--------|
| 20900023 | T1219 | SPOON NET LATEX HAIR MESH 16" (40CM) | 40CM        | 30CM         | 20CM      | 1  | 25      | €21.95 |
| 20900024 | T1275 | SPOON NET LATEX HAIR MESH 18" (45CM) | 45CM        | 35CM         | 25CM      | 1  | 25      | €22.95 |
| 20900025 | T1331 | SPOON NET LATEX HAIR MESH 20" (50CM) | 50CM        | 40CM         | 30CM      | 1  | 25      | €23.95 |

## LATEX MATCH ALLROUND

These nets have been designed for landing bigger fish and are available in two sizes. Totally fish-friendly and manufactured with a quick-dry, latex dipped, hexamesh fabric. The sides are 8.5mm so the net moves through the water with ease. The base of the net is manufactured with a 2.5mm rubber dipped hair mesh, to avoid the hook or hair from tangling in the net. The softness of the material avoids damage to the fish. The latex dip makes this net even more durable and longer lasting.

- > Durable lifting-assist nylon spreader block for safe and easy fish handling
- > Sturdy red aluminum frame
- > Quick-dry
- > Black and red 8.5mm and 2.5mm latex dipped hexamesh fabric
- > Available in two large sizes (18"/45cm – 20"/50cm)



| CODE     | TREF  | DESCRIPTION                               | FRAME WIDTH | FRAME HEIGHT | NET DEPTH | SU | CTN QTY | RRP    |
|----------|-------|---|-------------|--------------|-----------|----|---------|--------|
| 20900015 | T1219 | SPOON NET LATEX MATCH ALLROUND 18" (45CM) | 45CM        | 35CM         | 25CM      | 1  | 25      | €21.95 |
| 20900016 | T1275 | SPOON NET LATEX MATCH ALLROUND 20" (50CM) | 50CM        | 40CM         | 30CM      | 1  | 25      | €22.95 |

## LATEX BIG FISH

Ideal for netting big fish even in running water. The larger 8.5mm latex dipped hexamesh fabric moves through the water with ease. The latex protected mesh makes these nets hook-proof. The softness of the material avoids damage to the fish while the latex dip ensures durability because slime and smell are not absorbed. These nets dry faster and barely smell when totally dry.

- > Durable lifting-assist nylon spreader block for safe and easy fish landing
- > Sturdy red aluminum frame
- > Quick-dry
- > Black and red 2.5mm latex dipped hexamesh fabric
- > Available in three sizes (16"/40cm, 18"/45cm and 20"/50cm)



| CODE     | TREF  | DESCRIPTION                          | FRAME WIDTH | FRAME HEIGHT | NET DEPTH | SU | CTN QTY | RRP    |
|----------|-------|--------------------------------------|-------------|--------------|-----------|----|---------|--------|
| 20900017 | T1219 | SPOON NET LATEX HAIR MESH 16" (40CM) | 40CM        | 30CM         | 20CM      | 1  | 25      | €21.95 |
| 20900018 | T1275 | SPOON NET LATEX HAIR MESH 18" (45CM) | 45CM        | 35CM         | 25CM      | 1  | 25      | €22.95 |
| 20900019 | T1331 | SPOON NET LATEX HAIR MESH 20" (50CM) | 50CM        | 40CM         | 30CM      | 1  | 25      | €23.95 |



## BIG SCOOPA 5500 LATEX



The ideal net for netting big carp and other species. The net has a diameter of 55cm with 9mm latex dipped mesh material, to protect the fish and making the mesh hook-proof. The softness of the material avoids damage to the fish. The latex dip ensures durability because slime and smell are not absorbed. These nets dry faster and barely smell when dry.

- > Durable lifting-assist nylon spreader block for safe and easy fish handling
- > Sturdy red aluminum frame
- > Quick-dry and virtually smell-free
- > Black 9mm latex dipped hexamash fabric
- > Available in 55cm



| CODE     | TREF  | DESCRIPTION           | DIAMETER | MESH SIZE | SU | CTN QTY | RRP    |
|----------|-------|-----------------------|----------|-----------|----|---------|--------|
| 20900031 | T1250 | BIG SCOOPA 5500 LATEX | 55CM     | 9MM       | 1  | 25      | €22.50 |

## BIG SCOOPA 6000 LATEX



The ideal net for netting big carp and other species. The net has a diameter of 55cm with 9mm latex dipped mesh material, to protect the fish and making the mesh hook-proof. The softness of the material avoids damage to the fish. The latex dip ensures durability because slime and smell are not absorbed. These nets dry faster and barely smell when dry.

- > Durable lifting-assist nylon spreader block for safe and easy fish handling
- > Sturdy red aluminum frame
- > Quick-dry and virtually smell-free
- > Black 9mm latex dipped hexamash fabric
- > Available in 55cm



| CODE     | TREF  | DESCRIPTION           | DIAMETER | MESH SIZE | SU | CTN QTY | RRP    |
|----------|-------|-----------------------|----------|-----------|----|---------|--------|
| 20900032 | T1386 | BIG SCOOPA 6000 LATEX | 60CM     | 11MM      | 1  | 25      | €24.95 |

## DOUBLE-MESH FAST NET

These nets are available in two of the most popular sizes, 45cm and 50cm. They are manufactured with an ultralight aluminium frame and super soft, fish friendly 6mm double mesh. This makes them incredibly manoeuvrable in the water allowing the angler to land fish quicker.

- > Durable lifting-assist nylon spreader block for safe and easy fish handling
- > Sturdy lightweight aluminium frame
- > Black 6mm, super soft and fish friendly double mesh fabric
- > No smell absorption
- > Available in two sizes (18"/45cm and 20"/50cm)



| CODE     | TREF  | DESCRIPTION                           | FRAME WIDTH | FRAME HEIGHT | NET DEPTH | SU | CTN QTY | RRP    |
|----------|-------|---------------------------------------|-------------|--------------|-----------|----|---------|--------|
| 20900029 | T1053 | SPOON DOUBLE MESH FAST NET 18" (45CM) | 45CM        | 35CM         | 30CM      | 1  | 25      | €18.95 |
| 20900030 | T1108 | SPOON DOUBLE MESH FAST NET 20" (50CM) | 50CM        | 40CM         | 33CM      | 1  | 25      | €19.95 |



# MONO GHOST NET

This 7mm square knitted mono-mesh ghost net allows quicker water flow when netting and does not spook the fish. Ideal when fishing on running waters.

- > Durable lifting-assist nylon spreader block for safe and easy fish handling
- > Sturdy red aluminum frame
- > Quick-dry
- > No smell absorption
- > Transparent nylon ghost mesh
- > Available in two sizes (18"/45cm and 20"/50cm)



| CODE     | TREF  | DESCRIPTION                              | FRAME WIDTH | FRAME HEIGHT | NET DEPTH | SU | CTN QTY | RRP    |
|----------|-------|--|-------------|--------------|-----------|----|---------|--------|
| 20900013 | T1219 | SPOON NET MONO MESH GHOST NET 18" (45CM) | 45CM        | 35CM         | 25CM      | 1  | 25      | €21.95 |
| 20900014 | T1275 | SPOON NET MONO MESH GHOST NET 20" (50M)  | 50CM        | 40CM         | 30CM      | 1  | 25      | €22.95 |

# NTR COMMERCIAL LANDING NET

The NTR commercial spoon landing net offers high quality and exceptional value for money.

- > Lightweight ABS block
- > Sturdy aluminum frame
- > 8mm big fish hexamash fabric

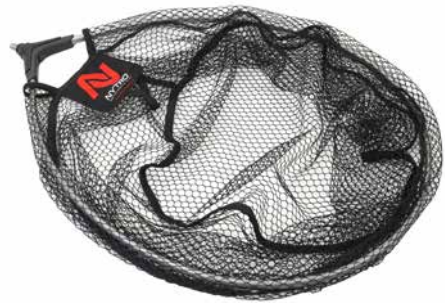

| CODE     | TREF | DESCRIPTION                              | FRAME WIDTH | FRAME HEIGHT | NET DEPTH | SU | CTN QTY | RRP    |
|----------|------|--|-------------|--------------|-----------|----|---------|--------|
| 20900009 | T831 | SPOON NET START-UP COMMERCIAL 18" (45CM) | 45CM        | 35CM         | 25CM      | 1  | 25      | €14.95 |





HANDING NET

NYTRO  
since first



## NTR COMMERCIAL HANDLE PUT-OVER



The NTR Commercial handle features a fast-taper carbon-graphite construction, making it lightweight and easy to handle. With sufficient power-reserves to net and land fish quickly and securely, this landing net handle offers maximum value for money. Length 3m.

| CODE     | TREF  | DESCRIPTION                | LENGTH | SECTIONS | TRANSPORT LENGTH | SU | CTN QTY | RRP    |
|----------|-------|----------------------------|--------|----------|------------------|----|---------|--------|
| 20500007 | T1942 | NTR LANDING NET HANDLE 300 | 45CM   | 35CM     | 160CM            | 1  | 25      | €34.95 |

## IMPAX COMMERCIAL PUT OVER



The Impax Commercial landing net handles are the ideal net handles in a very popular price segment. Designed for fishing commercials, these handles are lightweight yet incredibly strong enabling them to be manoeuvred fast and land carp and FI's quickly. Featuring a put-over joint with glued and pinned heads for extra security. Available in two different lengths: 2m and 3m.

| CODE     | TREF  | DESCRIPTION                   | LENGTH | SECTIONS | TRANSPORT LENGTH | WEIGHT | SU | CTN QTY | RRP    |
|----------|-------|-------------------------------|--------|----------|------------------|--------|----|---------|--------|
| 20500001 | T2219 | IMPAX COMMERCIAL 200 PUT OVER | 2.0M   | 2        | 112CM            | 148G   | 1  | 25      | €39.95 |
| 20500002 | T2775 | IMPAX COMMERCIAL 300 PUT OVER | 3.0M   | 3        | 112CM            | 260G   | 1  | 25      | €49.95 |

## IMPAX COMMERCIAL TELE



The Impax Commercial telescopic landing net handle is lightweight yet incredibly strong. Ideal for carp and FI fishing. Featuring a telescopic joint with glued and pinned head for extra security. Available in 3m.

| CODE     | TREF  | DESCRIPTION               | LENGTH | SECTIONS | TRANSPORT LENGTH | WEIGHT | SU | CTN QTY | RRP    |
|----------|-------|---------------------------|--------|----------|------------------|--------|----|---------|--------|
| 20500003 | T2775 | IMPAX COMMERCIAL 300 TELE | 3.0M   | 3        | 110CM            | 270G   | 1  | 25      | €49.95 |



## SOLUS DUO NET HANDLE



The Solus Duo net handle features two threads in the top and middle sections enabling it to be used at 2.2m or 3.3m lengths, depending on whatever the circumstances require. The lightweight, multi-purpose Solus Duo carbon handle, is strong with a super glide mat finish and is designed for all-round fishing conditions.

| CODE     | TREF  | DESCRIPTION          | LENGTH    | SECTIONS | TRANSPORT LENGTH | WEIGHT | SU | CTN QTY | RRP    |
|----------|-------|----------------------|-----------|----------|------------------|--------|----|---------|--------|
| 20500008 | T3331 | SOLUS DUO NET HANDLE | 2.2M/3.3M | 3        | 120CM            | 314G   | 1  | 20      | €59.95 |

## SUBLIME SLIM STICK



The Sublime Slim Stick, put-over landing net handle is lightweight, comfortable and easy to handle. This ultra slim diameter net handle is ideal for fast maneuvering and quick netting of fish whether fishing competitions or just for pleasure. The handle is super rigid and the screw thread head is properly glued and pinned for extra security. Available in 3.5m and three unequal sections so you can use it at one section shorter if required.

| CODE     | TREF  | DESCRIPTION                     | LENGTH | SECTIONS | TRANSPORT LENGTH | WEIGHT | SU | CTN QTY | RRP    |
|----------|-------|---------------------------------|--------|----------|------------------|--------|----|---------|--------|
| 20500006 | T4442 | SUBLIME SLIM STICK 350 PUT OVER | 3.5M   | 3        | 141CM            | 263G   | 1  | 20      | €79.95 |

## SUBLIME CARP MATCH PUT OVER



The Sublime Carp Match landing nets are lightweight, stiff and extremely strong. Available in 3m and 4m they are also ideal when fishing matches on natural venues for bigger fish. Their strength allows the use of larger net heads. Featuring a put-over joint, plus the screw thread head is glued and pinned for added security.

| CODE     | TREF  | DESCRIPTION                     | LENGTH | SECTIONS | TRANSPORT LENGTH | WEIGHT | SU | CTN QTY | RRP    |
|----------|-------|---------------------------------|--------|----------|------------------|--------|----|---------|--------|
| 20500004 | T3886 | SUBLIME CARP MATCH 300 PUT OVER | 3.0M   | 3        | 128CM            | 293G   | 1  | 20      | €69.95 |
| 20500005 | T4442 | SUBLIME CARP MATCH 400 PUT OVER | 4.0M   | 4        | 128CM            | 425G   | 1  | 20      | €79.95 |





S  
E  
I  
J  
O  
R  
B  
E



## V-TOP FEEDA BROLLY

Sitting protected from the rain and still being able to cast a feeder was the goal when developing our V-Top Feeda Brolly. The tilt system allows for additional adjustment. All seams are taped so this brolly not only protects you from the sun but also from drizzle or rain burst.

- > 210T Polyester
- > Steel ribs
- > V-Top front
- > Waterproof taped seams
- > Easy operation
- > Tilt-system
- > Includes transport pouch



| CODE     | TREF  | DESCRIPTION                  | MEASUREMENT | WEIGHT | SU | CTN QTY | RRP    |
|----------|-------|------------------------------|-------------|--------|----|---------|--------|
| 20700001 | T3331 | V-TOP FEEDA BROLLY 50"/250CM | 50"/250CM   | 2.6KG  | 1  | 5       | €59.95 |

## COMMERCIAL BROLLY

Great value for money is the best way to describe this 50"/250cm competition brolly. Ideal protection again all-weather conditions and looking great on the bank too!

- > 210D nylon fabric
- > Steel ribs
- > Conventional shape
- > Waterproof taped seams
- > Easy operation
- > Tilt-system
- > Ideal protection in rain, wind and sun
- > Includes transport pouch



| CODE     | TREF  | DESCRIPTION                 | MEASUREMENT | WEIGHT | SU | CTN QTY | RRP    |
|----------|-------|-----------------------------|-------------|--------|----|---------|--------|
| 20700002 | T3886 | COMMERCIAL BROLLY 50"/250CM | 50"/250CM   | 2.5kg  | 1  | 6       | €69.95 |

## SQUARE-ONE MATCH BROLLY

The Square-One Match Brolly is our rectangular lightweight umbrella, offering maximum protection against the sun, rain and wind. All seams are fully taped to assure these brollies are waterproof. Featuring a tilt system for optimal adjustment.

- > 210D nylon fabric
- > Steel ribs
- > Rectangular shape
- > Waterproof taped seams
- > Easy operation
- > Tilt-system
- > Ideal protection in rain, wind and sun
- > Includes transport pouch



| CODE     | TREF  | DESCRIPTION                       | MEASUREMENT | WEIGHT | SU | CTN QTY | RRP    |
|----------|-------|-----------------------------------|-------------|--------|----|---------|--------|
| 20700003 | T4442 | SQUARE-ONE MATCH BROLLY 50"/250CM | 50"/250CM   | 2.6KG  | 1  | 6       | €79.95 |



BROLLIES

NYTRO

## SPACE CREATOR FLATBACK 50

The Space Creator Flatback 50 is a versatile brolly featuring waterproof taped seams and lightweight fiberglass ribs for maximum support and stability. For extra protection in extreme weather conditions, we build these brollies with an extra-strong steel frame. Three pegging point allow you to secure the umbrella in windy conditions, so you stay fully protected at all times. Pegs are included!

- > 300D nylon fabric
- > 8mm fiberglass ribs
- > Waterproof taped seams
- > Three pegging points
- > Easy operation
- > Tilt-system
- > Ideal protection in rain, wind and sun
- > Includes peg set
- > Includes transport pouch



| CODE     | TREF  | DESCRIPTION                                 | MEASUREMENT | WEIGHT | SU | CTN QTY | RRP    |
|----------|-------|---|-------------|--------|----|---------|--------|
| 20700004 | T4997 | SPACE CREATOR FLATBACK50 250CM (INCL. PEGS) | 50"/250CM   | 2.4KG  | 1  | 6       | €89.95 |

## SPACE CREATOR MULTISPACE 60

The Space Creator Multispace 60 is the largest brolly in the range and is extremely versatile. It features waterproof taped seams and lightweight fiberglass ribs for maximum support and stability. For extra protection in extreme weather conditions these oversized brollies are manufactured with an extra strong steel frame and a tilt system.

- > 300D nylon fabric
- > 8mm fiberglass ribs
- > Waterproof taped seams
- > Easy operation
- > Tilt-system
- > Ideal protection in rain, wind and sun
- > Includes transport pouch



| CODE     | TREF  | DESCRIPTION                      | MEASUREMENT | WEIGHT | SU | CTN QTY | RRP    |
|----------|-------|----------------------------------|-------------|--------|----|---------|--------|
| 20700005 | T5553 | SPACE CREATOR MULTISPACE60 300CM | 60"/300CM   | 2.8KG  | 1  | 6       | €99.95 |

## BAIT PROTECTOR BROLLY

The ideal protection for your bait keeping it dry from rain. Also protects your bait from drying out in the sun.

- > 210T nylon fabric
- > Sturdy steel ribs
- > Waterproof taped seams
- > Easy operation
- > Tilt-system
- > Includes transport pouch



| CODE     | TREF  | DESCRIPTION           | MEASUREMENT | WEIGHT | SU | CTN QTY | RRP    |
|----------|-------|-----------------------|-------------|--------|----|---------|--------|
| 20700006 | T2219 | BAIT PROTECTOR BROLLY | 60x80CM     | 1KG    | 1  | 6       | €39.95 |





# NYTRO WATERS & ACCESSORIES



## SLS36 FEEDER STATION



The NyTRO SLS36 Station offers lots of comfort and above all, great value for money! This compact, space efficient seat box features an elegant, strong aluminium frame with a rigid sliding foot plate. The SLS36 Station comes standard with six, D36 black telescopic legs, two of which featuring a threaded end cap. In addition, there are two 40mm side drawer units and a padded seat featuring a carbon friendly pole holder. There is a spirit level on the back of the frame to allow perfect positioning. A great seat box with for the demanding pole and feeder angler.

- > Strong, elegant aluminium frame
- > Six telescopic, black D36 aluminium legs
- > Two threaded end cap inserts
- > Sliding foot plate
- > Padded seat with pole retaining strap
- > Two 40mm side drawer units
- > Oversized locking system handle knobs
- > Spirit level for total comfort
- > Flexible mud feet
- > Adjustable shoulder strap

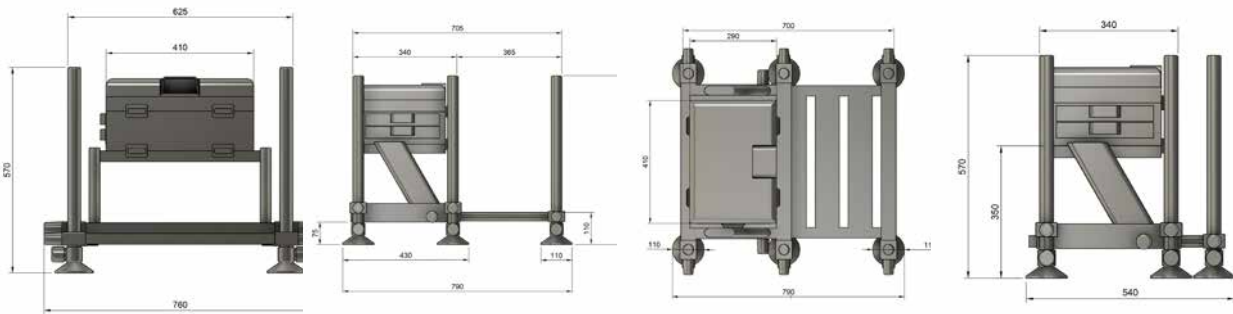

| CODE     | TREF   | DESCRIPTION   | SU | CTN QTY | RRP     |
|----------|--------|---------------|----|---------|---------|
| 21500004 | T24997 | SLS36 STATION | 1  | 1       | €399.95 |



## SLS36R STATION WITH SWIVEL SEAT

**NEW**

The Nytro SLS36R Station with Swivel Seat offers even more comfort and great value for money! Just like the SLS36 Station the SLS36R is a compact, space efficient seat box featuring a 360° swivel seat. It has an elegant, strong aluminium frame with a rigid sliding foot plate and six D36 black telescopic legs, two of which feature a threaded end cap. There are two spirit levels, located on the back and the side of the frame to allow perfect positioning. A fantastic seat box for the demanding pole and feeder angler.

- > Strong, elegant aluminium frame
- > 360° swivel seat with padded cushions
- > Six telescopic, black D36 aluminium legs
- > Two threaded end cap inserts
- > Sliding foot plate
- > Padded seat with pole retaining strap
- > One single side draw unit
- > Oversized locking system handle knobs
- > Two spirit levels for perfect positioning
- > Flexible mud feet
- > Adjustable shoulder strap



| CODE     | TREF   | DESCRIPTION                     | SU | CTN QTY | RRP     |
|----------|--------|---------------------------------|----|---------|---------|
| 21500006 | T31247 | SLS36R STATION WITH SWIVEL SEAT | 1  | 1       | €499.95 |

## SLS36 SWIVEL SEAT 360

**NEW**

Introducing our new SLS36 Swivel Seat with 360° rotation, designed to enhance your fishing experience. This foldable seat offers more comfort by providing greater mobility and flexibility, enabling you to cast with precision and sit with ease.

The padded seat and backrest offer exceptional comfort, making it ideal for long fishing sessions. The cushioning provides crucial support for your back, which is particularly beneficial for those with back problems, helping to reduce strain and discomfort over extended periods. Upgrade your SLS36 seat box with our ergonomic, comfortable, and versatile SLS36 Swivel Seat.

- > Strong, elegant aluminium frame
- > 360° swivel seat with padded cushions
- > Six telescopic, black D36 aluminium legs
- > Two threaded end cap inserts
- > Sliding foot plate
- > Padded seat with pole retaining strap
- > One single side draw unit
- > Oversized locking system handle knobs
- > Two spirit levels for perfect positioning
- > Flexible mud feet
- > Adjustable shoulder strap



| CODE     | TREF  | DESCRIPTION           | SU | CTN QTY | RRP     |
|----------|-------|-----------------------|----|---------|---------|
| 21500005 | T8122 | SLS36 SWIVEL SEAT 360 | 1  | 1       | €129.95 |



## IMPAX COMFIBOX CB3 FEEDER BOX

The fully adjustable Impax Comfibox Seat System CB3 'Feeder' features a nicely padded seat and reclining backrest plus a 40mm side drawer unit to keep your accessories handy and a 130mm deep base compartment. The back support is ideal for longer sessions on the bank, offering lots of comfort.

- > Stable frame design
- > Padded seat
- > Reclining padded back rest
- > 1x 40mm Side drawer unit
- > 1x 130mm Deep base compartment
- > Spirit level
- > Four single, black D36 aluminium legs (50cm)
- > Flexible mud feet
- > Adjustable shoulder strap
- > Telescopic D36 legs and footplate are available separately

| CODE     | TREF   | DESCRIPTION                   | SU | CTN QTY | RRP     |
|----------|--------|-------------------------------|----|---------|---------|
| 21500003 | T12497 | IMPAX COMFIBOX CB3 FEEDER BOX | 1  | 1       | €199.95 |



## IMPAX COMFIBOX CB2

The Impax Comfibox Seat System CB2 features a padded reclining backrest. Support that is ideal for longer sessions on the bank, offering sufficient comfort while waiting for a bite. The seat box is fully adjustable and comes with a 130mm deep base compartment.

- > Stable frame design
- > Padded seat
- > Reclining padded back rest
- > 1x 130mm deep base compartment
- > Four single, black D36 aluminium legs (50cm)
- > Flexible mud feet
- > Adjustable shoulder strap
- > Telescopic D36 legs and footplate are available separately

| CODE     | TREF   | DESCRIPTION        | SU | CTN QTY | RRP     |
|----------|--------|--------------------|----|---------|---------|
| 21500002 | T11247 | IMPAX COMFIBOX CB2 | 1  | 1       | €179.95 |



## IMPAX COMFIBOX CB1

The Impax Comfibox Seat System CB1 is our best-value-for-money seat box. Manufactured with a durable aluminium framework and featuring a 130mm deep base compartment. Telescopic legs and a footplate are available as separate add-on items.

- > Stable aluminium frame design
- > Padded seat
- > 1x 130mm deep base compartment
- > Four single, black D36 aluminium legs (50cm)
- > Flexible mud feet
- > Adjustable shoulder strap
- > Telescopic D36 legs and footplate are available separately

| CODE     | TREF  | DESCRIPTION                   | SU | CTN QTY | RRP     |
|----------|-------|-------------------------------|----|---------|---------|
| 21500001 | T9372 | IMPAX COMFIBOX CB1 NO DRAWERS | 1  | 1       | €149.95 |







## IMPAX FEEDER CHAIR

The Impax D25 Feeder Chair features a robust steel frame with adjustable, telescopic legs and flexible mud feet. Super stable, even on muddy and uneven ground. The frame is built in such a way that accessories can be mounted on both the front and the rear legs of the chair.

- > Stable steel frame
- > Four telescopic 25mm legs
- > Flexible ABS mud feet

| CODE     | TREF   | DESCRIPTION            | SU | CTN QTY | RRP     |
|----------|--------|------------------------|----|---------|---------|
| 21500020 | T11247 | IMPAX D25 FEEDER CHAIR | 1  | 1       | €179.95 |



## IMPAX X36 SINGLE / TELESCOPIC LEG

Single, 50cm black aluminium D36 leg with flexible mud foot.

Telescopic, 50cm black aluminium D36 leg with flexible mud foot.

| CODE     | TREF  | DESCRIPTION              | SU | CTN QTY | RRP    |
|----------|-------|--------------------------|----|---------|--------|
| 21500010 | T719  | IMPAX X36 SINGLE LEG     | 1  | 1       | €12.95 |
| 21500011 | T1108 | IMPAX X36 TELESCOPIC LEG | 1  | 1       | €19.95 |



## IMPAX COMFIBOX LIGHT FOOTPLATE

Lightweight aluminium foot plate, designed to fit the Comfibox CB1, 2 and 3.

| CODE     | TREF  | DESCRIPTION                    | SU | CTN QTY | RRP    |
|----------|-------|--------------------------------|----|---------|--------|
| 21500012 | T5553 | IMPAX COMFIBOX LIGHT FOOTPLATE | 1  | 1       | €99.95 |



## SCREW CAP (SET/2)



Spare screw caps for 36mm legs. Which can be fitted to accommodate rod rests and other accessories.

| CODE     | TREF | DESCRIPTION       | SU | CTN QTY | RRP   |
|----------|------|-------------------|----|---------|-------|
| 21000041 | T250 | SCREW CAP (SET/2) | 1  | 50      | €4.50 |





## SLS36 40MM DEEP TRAY UNIT



Additional drawer units can be added to adjust the height of your seat box and of course to provide additional storage space for your terminal tackle.

The SLS 40mm Deep Tray Unit is equipped with reversed locks for optimal protection and security of the locking system on both the Impax Comfi Box range and SLS36 Solus Station.

| CODE     | TREF  | DESCRIPTION               | DIMENSIONS         | SU | CTN QTY | RRP    |
|----------|-------|---------------------------|--------------------|----|---------|--------|
| 21000003 | T1386 | SLS36 40MM DEEP TRAY UNIT | W44 X H30.5 X D6CM | 1  | 10      | €24.95 |



## SLS36 40MM DEEP TRAY + SIDEDRAWER



Additional drawer units can be added to adjust the height of your seat box and of course to provide additional storage space for your terminal tackle. The SLS40mm Deep Tray & Side Drawer Unit besides offering extra height and storage space also offers a side drawer to provide the ability to access your accessories and terminal tackle quick and easy. This Unit is equipped with reversed locks for optimal protection and security of the locking system on both the Impax Comfi Box range and SLS36 Station.

| CODE     | TREF  | DESCRIPTION                       | DIMENSIONS       | SU | CTN QTY | RRP    |
|----------|-------|-----------------------------------|------------------|----|---------|--------|
| 21000004 | T3331 | SLS36 40MM DEEP TRAY + SIDEDRAWER | W44 X H30X D13CM | 1  | 5       | €59.95 |



## SLS36 DEEP TRAY FRONT LOADERS



The Deep Tray & 2-Front Drawer Unit offers extra height and storage space with two easy access front drawers for accessories of all sorts.

| CODE     | TREF  | DESCRIPTION                   | SU | CTN QTY | RRP    |
|----------|-------|-------------------------------|----|---------|--------|
| 21000005 | T3886 | SLS36 DEEP TRAY FRONT LOADERS | 1  | 5       | €69.95 |



## SLS36 SHALLOW TRAY 2FR 1SIDE DRW



The ultimate tray unit is the combination of a Shallow Tray, plus 2-Front Drawers and a Sliding Side Drawer for maximum height adjustment and storage space.

| CODE     | TREF  | DESCRIPTION                      | SU | CTN QTY | RRP    |
|----------|-------|----------------------------------|----|---------|--------|
| 21000006 | T5553 | SLS36 SHALLOW TRAY 2FR 1SIDE DRW | 1  | 5       | €99.95 |





## SIDE TRAY 400

**CONNECT IT**  
SEATBOX ACCESSORIES

This lightweight, single-knuckle D36 Nytro side tray measures 41 x 32cm. The side tray comes with an insert for 25mm and 30mm legs.



| CODE     | TREF  | DESCRIPTION         | SU | CTN QTY | RRP    |
|----------|-------|---------------------|----|---------|--------|
| 21000001 | T1664 | IMPAX SIDE TRAY 400 | 1  | 10      | €29.95 |

## MULTI SIDE-TRAY 43X43

**CONNECT IT**  
SEATBOX ACCESSORIES

The lightweight Multi Side Tray is highly versatile and can be used in multiple ways. Attach it as a conventional side tray, a secondary corner tray, or a rear tray on your box. Crafted from high-quality composite material, it is designed to reduce weight while maintaining durability.

The side tray is compatible with almost any seat box or feeder chair, thanks to the supplied inserts (25mm and 30mm) or without an insert for 36mm fittings.



| CODE     | TREF  | DESCRIPTION           | SU | CTN QTY | RRP    |
|----------|-------|-----------------------|----|---------|--------|
| 21000015 | T2775 | MULTI SIDE-TRAY 43X43 | 1  | 5       | €49.95 |

## X36 FEEDERARM

**CONNECT IT**  
SEATBOX ACCESSORIES

This versatile D36 adjustable and telescopic feeder arm will fit all 36mm legs and comes supplied with additional inserts for 25mm and 30mm legs.



| CODE     | TREF  | DESCRIPTION     | SU | CTN QTY | RRP    |
|----------|-------|-----------------|----|---------|--------|
| 21000002 | T1831 | IMPAX FEEDERARM | 1  | 10      | €32.95 |



## TOP ROOST KIT



Designed to ensure that top kits and rods are stored safely and securely. Manufactured with high quality EVA and composite materials and available in two sizes, six sections and eight sections.



| CODE     | TREF | DESCRIPTION     | SU | CTN QTY | RRP    |
|----------|------|-----------------|----|---------|--------|
| 21000020 | T553 | TOP ROOST KIT 6 | 1  | 50      | €9.95  |
| 21000021 | T664 | TOP ROOST KIT 8 | 1  | 50      | €11.95 |

## SIDE ROOST KIT



The Side Roost Kits are compatible with almost any seat box or feeder chair, thanks to the supplied inserts (25mm and 30mm) or without an insert for 36mm fittings.



| CODE     | TREF | DESCRIPTION      | SU | CTN QTY | RRP    |
|----------|------|------------------|----|---------|--------|
| 21000022 | T831 | SIDE ROOST KIT 6 | 1  | 30      | €14.95 |
| 21000023 | T942 | SIDE ROOST KIT 8 | 1  | 30      | €16.95 |

## POLE SUPPORT ALLROUND



The Nytro Pole Support Allround is easy to use and fully adjustable in height. Designed with durable EVA and high-quality composite materials. It is compatible with almost any seat box, thanks to the supplied inserts (25mm and 30mm) or without an insert for 36mm fittings.



| CODE     | TREF  | DESCRIPTION           | SU | CTN QTY | RRP    |
|----------|-------|-----------------------|----|---------|--------|
| 21000024 | T3886 | POLE SUPPORT ALLROUND | 1  | 10      | €69.95 |

## UP & OVER POLE REST



The Nytro Up and Over Pole Rest is ideal for keeping your pole secure while balling in bait or providing added support. This versatile rest can also be used as a rod butt rest or to hold your landing net handle in place, making it a highly practical accessory for any angler.



| CODE     | TREF  | DESCRIPTION           | SU | CTN QTY | RRP    |
|----------|-------|-----------------------|----|---------|--------|
| 21000025 | T1108 | POLE SUPPORT ALLROUND | 1  | 20      | €19.95 |

## RIPPLE BARS

NEW

**CONNECT IT**  
SEATBOX ACCESSORIES

Nytro Ripple Bars are designed for use with rod rest heads, butt rests, pole grips, and pole socks. They are available in three variations: Single (short, medium, and long), double (medium and long), and even a long triple. The double and triple models feature two threads on the uprights, allowing for the attachment of multiple accessories. Additionally, they are useful for holding pole sections when not in use. Nowadays, double ripple bars are often used for fishing with two rods, attaching a single rod rest to each screw thread.

They are compatible with almost any seat box or feeder chair, thanks to the supplied inserts (25mm and 30mm) or without an insert for 36mm fittings.



| CODE     | TREF  | DESCRIPTION              | SU | CTN QTY | RRP    |
|----------|-------|--------------------------|----|---------|--------|
| 21000026 | T997  | RIPPLE BAR SINGLE SHORT  | 1  | 30      | €17.95 |
| 21000027 | T1108 | RIPPLE BAR SINGLE MEDIUM | 1  | 30      | €19.95 |
| 21000028 | T1275 | RIPPLE BAR SINGLE LONG   | 1  | 30      | €22.95 |
| 21000029 | T1386 | RIPPLE BAR DOUBLE MEDIUM | 1  | 30      | €24.95 |
| 21000030 | T1553 | RIPPLE BAR DOUBLE LONG   | 1  | 30      | €27.95 |
| 21000031 | T1664 | RIPPLE BAR TRIPLE LONG   | 1  | 30      | €29.95 |

## SLS36 WHEEL KIT

NEW

**CONNECT IT**  
SEATBOX ACCESSORIES

Designed with the modern-day angler in mind, our seat box transportation solution simplifies the process of moving your gear with ease. This compact wheel kit is designed to fit the Nytro SLS36 seat box. The wheels fit on the sides and the puller handle fit underneath the footplate making transportation straightforward. The kit comes supplied with two robust wheels and a pull handle for easy manoeuvrability. The assembly is a breeze. This makes it the perfect choice for anglers who need a reliable, efficient, and strong transportation solution for their SLS36 seat box.

- > Perfect for the modern-day angler
- > Designed to make seat box transportation easy
- > Compact design and simple assembly
- > Compatible with the SLS36 seat box range
- > Supplied with two robust wheels and a pull handle



| CODE     | TREF  | DESCRIPTION     | SU | CTN QTY | RRP    |
|----------|-------|-----------------|----|---------|--------|
| 21400000 | T4442 | SLS36 WHEEL KIT | 1  | 1       | €79.95 |



SEATBOXES & CHAIRS

NYTRO



# KEEPNET ARM SHORT



This short, single keepnet arm is compatible with almost any seat box or feeder chair, thanks to the supplied inserts (25mm and 30mm) or without an insert for 36mm fittings.



| CODE     | TREF | DESCRIPTION       | SU | CTN QTY | RRP    |
|----------|------|-------------------|----|---------|--------|
| 21000032 | T719 | KEEPNET ARM SHORT | 1  | 20      | €12.95 |

# CROSS ARM (SHORT/LONG)



These 90-degree short and long cross arms are versatile and can be used with keepnets, rod roosts, pole socks, single rod rests, and more. They are compatible with nearly any seat box or feeder chair, thanks to the supplied inserts (25mm and 30mm) or without an insert for 36mm fittings.



| CODE     | TREF | DESCRIPTION     | SU | CTN QTY | RRP    |
|----------|------|-----------------|----|---------|--------|
| 21000033 | T779 | CROSS ARM SHORT | 1  | 50      | €13.95 |
| 21000034 | T831 | CROSS ARM LONG  | 1  | 50      | €14.95 |

# TOOL BAR SINGLE (SHORT/LONG)



The Tool Bar in 50cm and 90cm is designed to attach to one leg, providing space for two and three keepnets for resp. the 50cm and 90cm model. By using one on each front leg, you can hold a total of four to six keepnets, freeing up ample space in front of you to land fish effortlessly. Compatible with nearly any seat box, thanks to the supplied inserts (25mm and 30mm) or without an insert for 36mm fittings.



| CODE     | TREF  | DESCRIPTION           | SU | CTN QTY | RRP    |
|----------|-------|-----------------------|----|---------|--------|
| 21000035 | T2219 | TOOL BAR SINGLE LONG  | 1  | 20      | €39.95 |
| 21000036 | T1831 | TOOL BAR SINGLE SHORT | 1  | 20      | €32.95 |

# BROLLY ARM (SHORT/LONG)



The Nytro Brolly Arms come in two sizes, short and long and are designed to securely attach your brolly to your seat box or feeder chair. This ensures that both you and your bait and tackle are protected, regardless of the weather. The two knuckles and aluminum frame provide excellent stability and the arm's length allows you to rotate the brolly to your desired position. Compatible with nearly any seat box, thanks to the supplied inserts (25mm and 30mm) or without an insert for 36mm fittings.



| CODE     | TREF  | DESCRIPTION      | SU | CTN QTY | RRP    |
|----------|-------|------------------|----|---------|--------|
| 21000037 | T1442 | BROLLY ARM SHORT | 1  | 20      | €25.95 |
| 21000038 | T1831 | BROLLY ARM LONG  | 1  | 10      | €32.95 |



# STARKX-ULTRA RANGE

**NYTRO**  
performance first

**NYTRO**  
performance first

**STARKX**  
ULTRA RANGE  
ACCESSORY & BAIT BOWL

**STARKX**  
ULTRA RANGE  
12L BAIT BOWL

**STARKX**  
ULTRA RANGE  
24 ACCESSORY & BAIT BOWL

**STARKX**  
ULTRA RANGE



## STARKX EVA ACCESSORY & BAIT BOWL

### EVA-ULTRA RANGE

The waterproof StarkX Accessory & Bait Bowl comes in three popular sizes. They are very practical for holding a large amount of ground bait, pellets or other loose feed items. A strong and sturdy semi-hard case featuring heavy-duty EVA material and oversized aluminium ring in the top for added support.

- > Mixed 1.5mm and 1mm EVA fabric
- > Easy-clean
- > Waterproof welding
- > Available in three sizes (Small, Medium & Large)



| CODE     | TREF  | DESCRIPTION                                  | LENGTH | WIDTH | HEIGHT | SU | CTN QTY | RRP    |
|----------|-------|--|--------|-------|--------|----|---------|--------|
| 22400001 | T831  | STARKX 1818 EVA ACCESSORY & BAIT BOWL SMALL  | 18CM   | 18CM  | 10CM   | 1  | 20      | €14.95 |
| 22400002 | T942  | STARKX 2121 EVA ACCESSORY & BAIT BOWL MEDIUM | 21CM   | 21CM  | 10CM   | 1  | 20      | €16.95 |
| 22400003 | T1108 | STARKX 2424 EVA ACCESSORY & BAIT BOWL LARGE  | 24CM   | 24CM  | 10CM   | 1  | 20      | €19.95 |

## STARKX EVA SQUARE ACCESSORY ZIP-UP CASE

### EVA-ULTRA RANGE

The ideal storage case for a wide range of accessories and feeders. Available in three sizes. Featuring a clear view lid and strong zippers with branded puller. A strong and sturdy semi-hard case featuring heavy-duty EVA material and oversized aluminium ring in the top for added support.

- > Mixed 1.5mm and 1mm EVA fabric
- > Easy-clean
- > Strong zipper and zipper puller
- > Waterproof welding
- > Available in three sizes (Small, Medium & Large)



| CODE     | TREF  | DESCRIPTION   | LENGTH | WIDTH | HEIGHT | SU | CTN QTY | RRP    |
|----------|-------|---|--------|-------|--------|----|---------|--------|
| 22400004 | T1108 | STARKX 1818 EVA SQUARE ACCESSORY ZIP-UP CASE SMALL  | 18CM   | 18CM  | 10CM   | 1  | 20      | €19.95 |
| 22400005 | T1386 | STARKX 2121 EVA SQUARE ACCESSORY ZIP-UP CASE MEDIUM | 21CM   | 21CM  | 10CM   | 1  | 20      | €24.95 |
| 22400006 | T1608 | STARKX 2424 EVA SQUARE ACCESSORY ZIP-UP CASE LARGE  | 24CM   | 24CM  | 10CM   | 1  | 20      | €28.95 |





## STARKX 2+1 FEEDER TRAY

### EVA-ULTRA RANGE

This EVA Feeder Tray system is developed to hold 2 x 1212 and 1 x 2412 EVA tubs. Ideal for short sessions using a small variety of pellets and groundbait. Of just for storage of feeder, pellet wagglers and accessories. The clear view lid comes with a webbing strap handle for added strength.

Tubs included: 2 x model 1212 and 1 x model 2412 EVA Bait and Accessory tubs  
Spare tubs are available.

- > Mixed 1.5mm and 1mm EVA fabric
- > Easy-clean
- > Waterproof welding
- > Durable zippers
- > Clear view lid
- > Base size: L27xW27xH9cm



| CODE     | TREF  | DESCRIPTION            | SU | CTN QTY | RRP    |
|----------|-------|------------------------|----|---------|--------|
| 22400048 | T2775 | STARKX 2+1 FEEDER TRAY | 1  | 20      | €49.95 |

## STARKX EVA SYSTEM TRAY 3+1

### EVA-ULTRA RANGE

This EVA system is designed to hold four different tubs for use with bait or small accessories. Featuring a clear view plastic lid and manufactured with sealed waterproof EVA material.

Tubs included: 3x Model 1212 and 1x Model 3812  
Spare tubs are available in three different sizes.

- > Mixed 1.5mm and 1mm EVA fabric
- > Easy-clean
- > Waterproof welding
- > Durable zippers
- > 4+1 Set includes:
  - 1 Base L40xW27xH8.5cm
  - 1 tub L38xW12xH8cm
  - 3 tubs L12xW12xH8cm



| CODE     | TREF  | DESCRIPTION                     | SU | CTN QTY | RRP    |
|----------|-------|---------------------------------|----|---------|--------|
| 22400007 | T3331 | STARKX 4027 EVA SYSTEM TRAY 3+1 | 1  | 10      | €59.95 |

## STARKX EVA SYSTEM TRAY 4+1

### EVA-ULTRA RANGE

This EVA system is designed to hold five different tubs for use with bait or small accessories like feeders. Featuring a clear view plastic lid and is manufactured with sealed waterproof EVA material.

Tubs included: 4x Model 1212 and 1x Model 2412  
Spare tubs are available in three different sizes.

- > Mixed 1.5mm and 1mm EVA fabric
- > Easy-clean
- > Waterproof welding
- > Durable zippers
- > Clear view lid
- > 4+1 Set includes:
  - 1 Base L40xW27xH8.5cm
  - 1 tub L24xW12xH8cm
  - 4 tubs L12xW12xH8cm



| CODE     | TREF  | DESCRIPTION                | SU | CTN QTY | RRP    |
|----------|-------|----------------------------|----|---------|--------|
| 22400008 | T3331 | STARKX EVA SYSTEM TRAY 4+1 | 1  | 10      | €59.95 |



## STARKX EVA BAIT & ACCESSORY CONTAINERS

### EVA-ULTRA RANGE

These very handy waterproof StarkX Bait & Accessory Containers (as packed inside the Systems Trays), also come as spares, so you can pre-pack your gear depending on where you fish. A strong and sturdy semi-hard container manufactured from heavy-duty EVA material and oversized aluminium ring in the top.

- > Mixed 1.5mm and 1mm EVA fabric
- > Easy-clean
- > Waterproof welding



| CODE     | TREF  | DESCRIPTION                                       | LENGTH | WIDTH | HEIGHT | SU | CTN QTY | RRP    |
|----------|-------|---|--------|-------|--------|----|---------|--------|
| 22400009 | T553  | STARKX 1212 EVA BAIT & ACCESSORY CONTAINER SMALL  | 12CM   | 12CM  | 8CM    | 1  | 20      | €9.95  |
| 22400010 | T886  | STARKX 2412 EVA BAIT & ACCESSORY CONTAINER MEDIUM | 24CM   | 12CM  | 8CM    | 1  | 20      | €15.95 |
| 22400011 | T1053 | STARKX 3812 EVA BAIT & ACCESSORY CONTAINER LARGE  | 38CM   | 12CM  | 8CM    | 1  | 20      | €18.95 |

## STARKX EVA ACCESSORY & BITS ZIP-UP CASES

### EVA-ULTRA RANGE

These very handy waterproof StarkX Accessory & Bits Zip cases come in three different sizes and are ideal deal for storing anything from small accessories, spare spools and feeders all the way to wagglers or hook bait tubs. A strong and sturdy semi-hard case for maximum protection of your gear, thanks to the heavy-duty EVA material and oversized aluminium ring in the top.

- > Mixed 1.5mm and 1mm EVA fabric
- > Easy-clean
- > Strong zipper and zipper puller
- > Waterproof welding



| CODE     | TREF  | DESCRIPTION   | LENGTH | WIDTH | HEIGHT | SU | CTN QTY | RRP    |
|----------|-------|---|--------|-------|--------|----|---------|--------|
| 22400012 | T831  | STARKX 1212 EVA ACCESSORY & BITS ZIP-UP CASE SMALL  | 12CM   | 12CM  | 8CM    | 1  | 20      | €14.95 |
| 22400013 | T1108 | STARKX 2412 EVA ACCESSORY & BITS ZIP-UP CASE MEDIUM | 24CM   | 12CM  | 8CM    | 1  | 20      | €19.95 |
| 22400014 | T1386 | STARKX 3812 EVA ACCESSORY & BITS ZIP-UP CASE LARGE  | 38CM   | 12CM  | 8CM    | 1  | 20      | €24.95 |

## STARKX EVA LIVE BAIT VENTILATION BOWLS

### EVA-ULTRA RANGE

These three strong EVA StarkX Live Bait Ventilation bowls are perfectly welded and come with an ultra-fine mesh in the lid for fresh storage and ventilation of worms, red worms and maggots. Store them securely in the refrigerator or on a cool concrete floor until your next fishing session. As used and recommended by several top-flight match anglers in the UK and Europe.

The smallest bowl is ideal for quick sessions with smaller portions of bait.

- > Mixed 1.5mm and 1mm EVA fabric
- > Easy-clean
- > Strong zipper and zipper puller
- > Waterproof welding



| CODE     | TREF  | DESCRIPTION                                      | LENGTH | WIDTH | HEIGHT | CAPACITY | SU | CTN QTY | RRP    |
|----------|-------|--|--------|-------|--------|----------|----|---------|--------|
| 22400041 | T1108 | STARKX 1414 EVA LIVE BAIT VENTILATION BOWL MINI  | 14CM   | 14CM  | 10CM   | 1.96L    | 1  | 20      | €19.95 |
| 22400015 | T1275 | STARKX 1818 EVA LIVE BAIT VENTILATION BOWL SMALL | 18CM   | 18CM  | 10CM   | 3.24L    | 1  | 20      | €22.95 |
| 22400016 | T1386 | STARKX 2424 EVA LIVE BAIT VENTILATION BOWL LARGE | 24CM   | 24CM  | 10CM   | 5.76L    | 1  | 20      | €24.95 |

## STARKX LIVE BAIT AIRBOWLS

### EVA-ULTRA RANGE

These StarkX EVA Live-bait Airbowls offer full air circulation for live bait and are an industry-first and was awarded the EFTTEX 2023 Runner-up Best New Product Award. These perfectly welded bait bowls are designed to hold live-bait such as maggots, red worms and dendrobaena worms. With the additional ventilation mesh on two sides plus the top, these tubs are better ventilated allowing your bait to stay fresh for longer, even on warm days on the bank.

- > Mixed 1.5mm and 1mm EVA fabric
- > Easy-clean
- > Nylon micro-mesh in lid and two sides for maximum ventilation
- > Waterproof welding
- > Durable zippers



| CODE     | TREF  | DESCRIPTION                   | LENGTH | WIDTH | HEIGHT | CAPACITY | SU | CTN QTY | RRP    |
|----------|-------|-------------------------------|--------|-------|--------|----------|----|---------|--------|
| 22400042 | T1386 | STARKX 1818 LIVE BAIT AIRBOWL | 18CM   | 18CM  | 10CM   | 3.24L    | 1  | 20      | €24.95 |
| 22400043 | T1553 | STARKX 2424 LIVE BAIT AIRBOWL | 24CM   | 24CM  | 10CM   | 5.76L    | 1  | 20      | €27.95 |

## STARKX EVA DROP BUCKET

### EVA-ULTRA RANGE

One of the most practical items in the range is the StarkX Drop Bucket. The strong EVA material always keeps its shape. The weighted strip on the side allows the bucket to tumble and scoop water with ease. Ideal when you are fishing from high platforms or on steep banks and require water for groundbait.

- > Mixed 1.5mm and 1mm EVA fabric
- > Waterproof welding
- > Easy-clean
- > Rope and storage winder included



| CODE     | TREF  | DESCRIPTION                 | LENGTH | WIDTH | HEIGHT | SU | CTN QTY | RRP    |
|----------|-------|-----------------------------|--------|-------|--------|----|---------|--------|
| 22400017 | T1108 | STARKX 1818 EVA DROP BUCKET | 18CM   | 18CM  | 18CM   | 1  | 20      | €19.95 |

## STARKX EVA WORM WASH & PELLET WETTER

### EVA-ULTRA RANGE

This StarkX Worm Wash and Pellet Wetter is manufactured using waterproof, heavy-duty EVA material. Featuring a rubber-dipped square mesh bag designed to wash your live bait or soak your pellets efficiently. This is a must-have for every angler when prepping bait on the bank or at home.

- > Mixed 1.5mm and 1mm EVA fabric
- > Easy-clean
- > Rubber-dipped mesh bag included
- > Waterproof welding
- > Durable zippers



| CODE     | TREF  | DESCRIPTION                               | LENGTH | WIDTH | HEIGHT | SU | CTN QTY | RRP    |
|----------|-------|---|--------|-------|--------|----|---------|--------|
| 22400018 | T1108 | STARKX 1818 EVA WORM WASH & PELLET WETTER | 18CM   | 18CM  | 10CM   | 1  | 20      | €19.95 |



STARKX EVA  
ULTRA LUGGAGE





## STARKX EVA TACKLE BITS CARRYALL

### EVA-ULTRA RANGE

The StarkX EVA Tackle & Bits Carryall is designed to hold multiple EVA zip-up cases, reels and other essential tackle items. For extra durability this carryall has been designed using strong, waterproof, carbon-look EVA material with unique moulded plastic handles and an extra-large zipper with zipper pullers. The plastic clips on the side of the bag are designed to hold a waist bag to keep your peg clean and tidy before leaving.

- > Rugged and robust carbon-look EVA material
- > Mixed 1.5mm and 1mm EVA fabric
- > Easy-clean
- > Waterproof
- > Durable zippers



| CODE     | TREF  | DESCRIPTION                          | LENGTH | WIDTH | HEIGHT | SU | CTN QTY | RRP    |
|----------|-------|--------------------------------------|--------|-------|--------|----|---------|--------|
| 22400019 | T2219 | STARKX 3625 EVA TACKLE BITS CARRYALL | 36CM   | 24CM  | 25CM   | 1  | 10      | €39.95 |

## STARKX EVA TACKLE CASE LARGE

### EVA-ULTRA RANGE

This large StarkX EVA Tackle Case is designed to hold multiple Tray Systems and lots of other gear or bait. Manufactured using strong and perfectly welded EVA materials and components the Tackle Case is water resistant and is perfect for adverse weather conditions. The webbing strap handles allow for easy transportation. Its compact, straight forward design helps store the luggage off and on the bank. The ideal storage carryall for all your coarse fishing gear.

- > Rugged and robust carbon-look EVA material
- > Mixed 1.5mm and 1mm EVA fabric
- > Easy-clean
- > Waterproof welding
- > Webbing straps
- > Durable zippers



| CODE     | TREF  | DESCRIPTION                   | LENGTH | WIDTH | HEIGHT | CAPACITY | SU | CTN QTY | RRP    |
|----------|-------|-------------------------------|--------|-------|--------|----------|----|---------|--------|
| 22400046 | T2775 | STARKX 4228 TACKLE CASE LARGE | 42CM   | 28CM  | 21CM   | 24.7L    | 1  | 10      | €49.95 |

## STARKX RIDDLE AND BAIT CARRYALL

### EVA-ULTRA RANGE

This Carryall is perfect when it comes to carrying riddles and ready-made groundbait. It is spacious enough to carry up to three riddles or just lots of bait. Prepare the groundbait prior to fishing and store it in this carryall to keep it ultra fresh and damp, ready to fish.

- > Rugged and robust carbon-look EVA material
- > Mixed 1.5mm and 1mm EVA fabric
- > Easy-clean
- > Waterproof
- > Webbing straps
- > Durable zippers
- > Dia. 42cm x H17cm



| CODE     | TREF  | DESCRIPTION                     | SU | CTN QTY | RRP    |
|----------|-------|---------------------------------|----|---------|--------|
| 22400045 | T3053 | STARKX RIDDLE AND BAIT CARRYALL | 1  | 5       | €54.95 |



STARKX EVA  
ULTRA LUGGAGE



## STARKX EVA COOLER BAG

### EVA-ULTRA RANGE

This large StarkX EVA Cooler Bag is designed to hold multiple Air- and Ventilation Bait Bowls, tubs, Tray Systems and tackle items. The bag is very versatile, whether as a cooler or tackle bag. Manufactured using strong and perfectly welded EVA materials and components the StarkX EVA Cooler Bag is water resistant and is perfect for adverse weather conditions. The thermos-foil inside is covered with a heavy-duty plastic skin, so as to protect the foil and the stitching. It also offers additional insulation. The webbing strap handles allow for easy transportation. The StarkX EVA Cooler Bag is spacious yet compact with a straight-forward design that helps store the luggage both on and off the bank.

- > Rugged and robust carbon-look EVA material
- > Thermal lining with plastic cover
- > Mixed 1.5mm and 1mm EVA fabric
- > Easy-clean
- > Waterproof welding
- > Webbing straps
- > Durable zippers



\*Contents not included

| CODE     | TREF  | DESCRIPTION           | LENGTH | WIDTH | HEIGHT | CAPACITY | SU | CTN QTY | RRP    |
|----------|-------|-----------------------|--------|-------|--------|----------|----|---------|--------|
| 22400047 | T3886 | STARKX EVA COOLER BAG | 50CM   | 30CM  | 22CM   | 33L      | 1  | 8       | €69.95 |

## STARKX EVA WATERPROOF NETBAG

### EVA-ULTRA RANGE

The StarkX EVA net bag is perfect to store both keepnets landing net heads, side trays and more. The heavy-duty EVA material is durable and rugged enough to withstand some serious use and abuse, which makes the net bag a very popular item in the range. Totally waterproof and therefore ideal for transporting and storing wet and smelly nets.

- > Rugged and robust carbon-look EVA material
- > Mixed 1.5mm and 1mm EVA fabric
- > Easy-clean
- > Waterproof
- > Webbing straps
- > Durable zippers



| CODE     | TREF  | DESCRIPTION                  | LENGTH | WIDTH | HEIGHT | SU | CTN QTY | RRP    |
|----------|-------|------------------------------|--------|-------|--------|----|---------|--------|
| 22400000 | T3608 | STARKX EVA WATERPROOF NETBAG | 60CM   | 50CM  | 21CM   | 1  | 8       | €64.95 |

## STARKX EVA WATERPROOF NETBAG XL

### EVA-ULTRA RANGE

This oversized StarkX EVA Net Bag XL is ideal when you need to carry multiple keepnets and landing net heads. We have made them wide enough to hold a minimum of four keepnets and high enough so you can also store the Space-creator keepnets easily and securely. Besides nets you can use these bags for side trays and accessories. The heavy-duty EVA material is durable and rugged enough to withstand some serious use and abuse which makes the net bag a very popular item in the range. Totally waterproof and therefore ideal for transporting and storing wet and smelly nets.

- > Rugged and robust EVA material
- > Mixed 1.5mm and 1mm EVA fabric
- > Easy-clean
- > Waterproof
- > Webbing straps
- > Durable zippers



| CODE     | TREF  | DESCRIPTION                      | LENGTH | WIDTH | HEIGHT | SU | CTN QTY | RRP    |
|----------|-------|----------------------------------|--------|-------|--------|----|---------|--------|
| 22400044 | T4442 | STARKX WATERPROOF KEEPNET BAG XL | 60CM   | 52CM  | 30CM   | 1  | 5       | €79.95 |





# WUGGAGGE & FISHTHARRE

**SUBLINE**  
HARD-SHELL 6-ROD HOLDALL



LUGGAGE & FISH CARE



# SUBLIME LUGGAGE

This premium range of match luggage has been designed for intensive use by the modern-day feeder angler. It is extremely practical, looks great and thanks to the incredibly strong PVC material, it is exceptionally rugged and robust. This well-designed range literally covers just about all the feeder angler's needs. From rod holdalls to carryalls, from cooler bags to keepnet bags and even tip tubes, Nytro has it covered. Every care has been taken to design luggage that will offer safe storage on and off the bank. Simply Sublime!

## SUBLIME 600D HARD-SHELL HOLDALLS

These hard-shell holdalls come in three different lengths and are designed to hold two, four and six made up ready rods. The central dividers keep the reels apart and protected to avoid any damage during stow-away and transport. Rods can be secured with Velcro straps inside. Fully lined and padded inside for extra protection. The hard shell that folds about the rods offers maximum protection during transport and storage. The separate storage areas within are spaciouly designed leaving nothing to chance. All handles and shoulder straps are designed for maximum comfort. The handles are positioned to balance the bag when carrying and covered with a neoprene which gives a nice secure and comfortable grip. The adjustable shoulder straps are fully padded and feature a non-slip surface for comfortably carrying when on your shoulder.

The Sublime 2-ready rods Holdall is the most basic version, offering all the afore mentioned advantages. The holdall offers one compartment separated by the padded protection divider between the reels. With a total length of 195cm this holdall is ideal for storing two-section rods up to 12ft/3.6m.

The Sublime 4- and 6-ready rods Holdalls are available in 165cm – 180cm and 195cm with additional pouches and sleeves on both sides of the holdall. These are the most versatile holdalls in the range and offer maximum storage facilities for rods, reels, brollies, landing net handles, distance sticks, tip tubes and even a margin pole. Sufficient space and



- > Hard-shell cover for maximum rod and reel protection
- > Heavy-duty 600D durable fabric
- > Easy-clean PVC outside
- > Rugged reinforced base
- > Water repellent
- > Thick padded shoulder strap with anti-slip surface

- > Soft neoprene handle and balanced grip positioning for extra comfort
- > Branded webbing straps
- > Durable SBS-quality zippers and branded pullers
- > Stylish design
- > Available in five different models

| CODE     | TREF   | DESCRIPTION               | SU | CTN QTY | RRP     |
|----------|--------|---------------------------|----|---------|---------|
| 22400020 | T4997  | SUBLIME 2-ROD HOLDALL 195 | 1  | 4       | €89.95  |
| 22400021 | T7219  | SUBLIME 4-ROD HOLDALL 165 | 1  | 4       | €129.95 |
| 22400022 | T8331  | SUBLIME 4-ROD HOLDALL 195 | 1  | 4       | €149.95 |
| 22400023 | T9997  | SUBLIME 6-ROD HOLDALL 180 | 1  | 4       | €179.95 |
| 22400024 | T10553 | SUBLIME 6-ROD HOLDALL 195 | 1  | 4       | €189.95 |





## SUBLIME TIP TUBE

The Sublime Tip Tube offers two compartments and is the ideal storage for all your feeder quiver tips.



| CODE     | TREF  | DESCRIPTION      | SU | CTN QTY | RRP    |
|----------|-------|------------------|----|---------|--------|
| 22400031 | T1664 | SUBLIME TIP TUBE | 1  | 50      | €29.95 |

## SUBLIME BAIT BAG SMALL



Sublime Bait Bags are designed in a rectangular shape, so they fit well on a trolley. The small version has a capacity of 35ltr and comes with a front facing pocket offering additional storage. The design of the Sublime Bait bags means you have a direct overview of the bait and the gear stored within. The padded sides allow the bag to stand right-up even if it is not filled completely. The bottom is reinforced to prevent moisture penetrating when on a wet surface.

- > Heavy-duty 600D durable fabric
- > Easy-clean PVC outside
- > Thick insulation lining
- > Rugged reinforced base
- > Water repellent
- > Thick padded shoulder strap with anti-slip surface
- > Soft neoprene handle and balanced grip positioning for extra comfort
- > Branded webbing straps
- > Durable SBS-quality zippers and branded pullers
- > Stylish design



| CODE     | TREF  | DESCRIPTION                         | LENGTH | WIDTH | HEIGHT | CAPACITY | SU | CTN QTY | RRP    |
|----------|-------|-------------------------------------|--------|-------|--------|----------|----|---------|--------|
| 22400025 | T2775 | SUBLIME BAIT BAG SMALL (ISO-LINING) | 42CM   | 30CM  | 28CM   | 35L      | 1  | 8       | €49.95 |

## SUBLIME BAIT BAG LARGE

Sublime Bait Bags are designed in a rectangular shape, so they fit well on a trolley. The large version has a capacity of 67ltr and comes with a front facing pocket for additional storage. The design of the Sublime Bait bags means you have a direct overview of the bait and the gear stored within. The padded sides allow the bag to stand right-up even if it is not filled completely. The bottom is reinforced to prevent moisture penetrating when on a wet surface.

- > Heavy-duty 600D durable fabric
- > Easy-clean PVC outside
- > Thick insulation lining
- > Rugged reinforced base
- > Water repellent
- > Thick padded shoulder strap with anti-slip surface
- > Soft neoprene handle and balanced grip positioning for extra comfort
- > Branded webbing straps
- > Durable SBS-quality zippers and branded pullers
- > Stylish design



| CODE     | TREF  | DESCRIPTION                         | LENGTH | WIDTH | HEIGHT | CAPACITY | SU | CTN QTY | RRP    |
|----------|-------|-------------------------------------|--------|-------|--------|----------|----|---------|--------|
| 22400026 | T3331 | SUBLIME BAIT BAG LARGE (ISO-LINING) | 64CM   | 35CM  | 30CM   | 67L      | 1  | 8       | €59.95 |



# SUBLIME ACCESSORY CARRYALL MEDIUM

This medium size Sublime Accessory Carryall is rectangular with a front facing pocket offering the ideal space for your most essential accessories. We designed this bag with a low profile so all your gear is easily accessible and the bag stands-up straight even when you have taken out most of your gear. The bottom is reinforced with anti-slip pads to keep the bag in position, even on a sloping bank and to prevent moisture penetrating when on a wet surface.

- > Heavy-duty 600D durable fabric
- > Easy-clean PVC outside
- > Padded lining
- > Rugged reinforced base
- > Water repellent
- > Thick padded shoulder strap with anti-slip surface
- > Soft neoprene handle and balanced grip positioning for extra comfort
- > Branded webbing straps
- > Durable SBS-quality zippers and branded pullers
- > Stylish design



| CODE     | TREF  | DESCRIPTION                       | LENGTH | WIDTH | HEIGHT | CAPACITY | SU | CTN QTY | RRP    |
|----------|-------|-----------------------------------|--------|-------|--------|----------|----|---------|--------|
| 22400027 | T2775 | SUBLIME ACCESSORY CARRYALL MEDIUM | 42CM   | 30CM  | 24CM   | 30L      | 1  | 10      | €49.95 |

# SUBLIME ACCESSORY CARRYALL LARGE

This large, square Sublime Accessory Carryall features a front facing pocket and offers the ideal space for your most essential accessories. Both the small and the large carryall have the same height, so kit is easily accessible and the bag stands-up straight even when you have taken out most of your gear. The bottom is reinforced with anti-slip pads to keep the bag in position, even on a sloping bank and to prevent moisture penetrating when on a wet surface.



- > Heavy-duty 600D durable fabric
- > Easy-clean PVC outside
- > Padded lining
- > Rugged reinforced base
- > Water repellent
- > Thick padded shoulder strap with anti-slip surface
- > Soft neoprene handle and balanced grip positioning for extra comfort
- > Branded webbing straps
- > Durable SBS-quality zippers and branded pullers
- > Stylish design

| CODE     | TREF  | DESCRIPTION                      | LENGTH | WIDTH | HEIGHT | CAPACITY | SU | CTN QTY | RRP    |
|----------|-------|----------------------------------|--------|-------|--------|----------|----|---------|--------|
| 22400028 | T3331 | SUBLIME ACCESSORY CARRYALL LARGE | 42CM   | 42CM  | 24CM   | 42L      | 1  | 5       | €59.95 |

# SUBLIME FEEDER BAG

The Sublime Feeder Bag is a luxurious storage bag with a reinforced base offering enough space for all the essential small accessories, like feeders or wagglers.. This feeder bag was designed to hold, for example, two 2+1 Feeder Trays, or eight 1818 StarkX Accessory Zip-up Cases. Besides the base storage area, the Sublime Feeder Bag also features a front compartment for additional essentials and a zip-up mesh pouch in the lid for storing documents, keys or your phone. Just like the other bags and carryalls in the Sublime range, the Sublime Feeder Bag comes with a padded shoulder strap and neoprene covered handles for maximum comfort when carrying to and from your peg.

- > Heavy-duty 600D durable fabric
- > Easy-clean PVC outside
- > Padded lining
- > Rugged reinforced base
- > Water repellent
- > Thick padded shoulder strap with anti-slip surface
- > Soft neoprene handle and balanced grip positioning for extra comfort
- > Branded webbing straps
- > Durable SBS-quality zippers and branded pullers
- > Stylish design

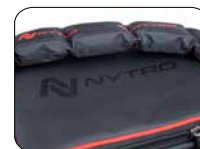

| CODE     | TREF  | DESCRIPTION        | LENGTH | WIDTH | HEIGHT | CAPACITY | SU | CTN QTY | RRP    |
|----------|-------|--------------------|--------|-------|--------|----------|----|---------|--------|
| 22400032 | T3053 | SUBLIME FEEDER BAG | 30CM   | 30CM  | 22CM   | 19.8L    | 1  | 20      | €54.95 |



## SUBLIME FEEDER BOX BAG

The Sublime Feeder Box Bag is a luxurious storage bag with a reinforced base offering more space than the regular Feeder Bag. It will hold up to three Feeder Tray Systems and offers enough space for a mix of Feeder Tackle Boxes too. Besides the base storage area, the Sublime Feeder Bag also features three front and side compartments for additional essentials. Just like the other bags and carryalls in the Sublime range, the Feeder bag comes with a padded shoulder strap and neoprene covered handles for maximum comfort when carrying your gear to and from your peg.



- > Heavy-duty 600D durable fabric
- > Easy-clean PVC outside
- > Padded lining
- > Rugged reinforced base
- > Water repellent
- > Thick padded shoulder strap with anti-slip surface
- > Soft neoprene handle and balanced grip positioning for extra comfort
- > Branded webbing straps
- > Durable SBS-quality zippers and branded pullers
- > Stylish design

| CODE     | TREF  | DESCRIPTION            | LENGTH | WIDTH | HEIGHT | CAPACITY | SU | CTN QTY | RRP    |
|----------|-------|------------------------|--------|-------|--------|----------|----|---------|--------|
| 22400033 | T3608 | SUBLIME FEEDER BOX BAG | 40CM   | 32CM  | 36CM   | 46L      | 1  | 5       | €64.95 |

## SUBLIME LONG ESSENTIALS BAG

The Sublime Long Essentials Bag is a luxurious storage bag with a reinforced base offering lots of space for roosts, pole rollers, feeder arms, spare legs and other essential seat box attachments. This long, large bag even features a storage solution on the outside for additional gear such as feeder rests.

Just like the other bags and carryalls in the Sublime range, the Long Essentials Bag comes with a padded shoulder strap and neoprene covered handles for maximum comfort when carrying your gear to and from your peg.



- > Heavy-duty 600D durable fabric
- > Easy-clean PVC outside
- > Padded lining
- > Rugged reinforced base
- > Water repellent
- > Thick padded shoulder strap with anti-slip surface
- > Soft neoprene handle and balanced grip positioning for extra comfort
- > Branded webbing straps
- > Durable SBS-quality zippers and branded pullers
- > Stylish design

| CODE     | TREF  | DESCRIPTION                 | LENGTH | WIDTH | HEIGHT | CAPACITY | SU | CTN QTY | RRP    |
|----------|-------|-----------------------------|--------|-------|--------|----------|----|---------|--------|
| 22400034 | T3886 | SUBLIME LONG ESSENTIALS BAG | 90CM   | 33CM  | 20CM   | 59.4L    | 1  | 5       | €69.95 |



## SUBLIME NET FLOAT

A simple but very functional bit of kit is the elasticated Sublime Net Float. No fiddling with adjustment bands, just mount this to the top of the landing net handle and screw-on your net. The Sublime Net Float offers enough buoyancy to keep just about every net head floating without much effort and in position ready to scoop.

- > Nylon fabric
- > High buoyancy foam
- > Elasticated central slot
- > Size 10cm



| CODE     | TREF | DESCRIPTION              | SIZE | SU | CTN QTY | RRP   |
|----------|------|--------------------------|------|----|---------|-------|
| 22400025 | T442 | SUBLIME NET FLOAT (THIN) | 10CM | 1  | 150     | €7.95 |



## SUBLIME NET & TRAY BAG

In the current environment of maximum weight limits for keepnets, many of the commercial anglers need to carry multiple nets. The Sublime Net & Tray bag offers space for three keepnets along with any heads. Plus, it features a large front pocket with two straps for side trays, riddles or extra nets.

Just like the other bags and carryalls in the Sublime range, the Sublime Net & Tray Bag comes with neoprene covered handles for maximum comfort when carrying your gear to and from your peg.

NB: This Net & Tray Bag is ideal in combination with the Waterproof Single Keepnet Bag, keeping your wet and dry nets separated.

- > Heavy-duty 600D durable fabric
- > Easy-clean PVC outside
- > Rugged reinforced base
- > Water repellent
- > Soft neoprene handle and balanced grip positioning for extra comfort
- > Branded webbing straps
- > Durable SBS-quality zippers and branded pullers
- > Stylish design

| CODE     | TREF  | DESCRIPTION            | LENGTH | WIDTH | HEIGHT | SU | CTN QTY | RRP    |
|----------|-------|------------------------|--------|-------|--------|----|---------|--------|
| 22400036 | T3331 | SUBLIME NET & TRAY BAG | 70CM   | 18CM  | 59CM   | 1  | 20      | €59.95 |

## SUBLIME WATERPROOF SINGLE KEEPNET BAG

The Sublime Single Keepnet Bag is a 500D waterproof PVC fabric bag that is ideal to store your wet keepnet (keeping them separate from dry ones). With a size L60xW5xH57, we have designed it big enough to hold larger square nets, including our Space-Creator range.

- > Heavy-duty 500D Waterproof PVC fabric
- > Waterproof
- > Easy-clean
- > Branded webbing straps
- > Durable SBS-quality zippers and branded pullers
- > Size L60xW5xH57cm



| CODE     | TREF  | DESCRIPTION                           | LENGTH | WIDTH | HEIGHT | SU | CTN QTY | RRP    |
|----------|-------|---------------------------------------|--------|-------|--------|----|---------|--------|
| 22400037 | T1664 | SUBLIME WATERPROOF SINGLE KEEPNET BAG | 60CM   | 5CM   | 57CM   | 1  | 40      | €29.95 |



# NYTRO SUBLIME ELASTICATED ROD PROTECTOR

The best protection for your feeder rods are the Sublime elasticated tip and butt rod protectors. The top and bottom cover are made of neoprene to maximum protection. In the center the sections are held together with a Velcro-neoprene strap. The stretchable strap makes this product suitable for rods of multiple lengths and for both two and three section rods to be packed and stored safely.



| CODE     | TREF | DESCRIPTION                       | SU | CTN QTY | RRP    |
|----------|------|-----------------------------------|----|---------|--------|
| 22400030 | T719 | SUBLIME ELASTICATED ROD PROTECTOR | 1  | 250     | €12.95 |



# NYTRO NEOPRENE ROD STRAPS

Set of two wide and narrow neoprene straps. Ideal to keep your rod sections together.

| CODE     | TREF | DESCRIPTION         | SU | CTN QTY | RRP   |
|----------|------|---------------------|----|---------|-------|
| 22400040 | T497 | NEOPRENE ROD STRAPS | 1  | 250     | €8.95 |

# NYTRO UNHOOKING MAT

With more and more fisheries demanding unhooking mats for landing bigger fish, we designed this stylish black unhooking mat with the Nytro logo on the side. It is manufactured using sturdy 600D PVC outside material with a 2cm foam padding ensuring the fish is protected while unhooking on the bank.

The mat easily folds-up in three sections and is secured for transit with two Velcro straps. Ideal for the coarse angler as it simply fits inside just about every keepnet bag.

- > Rugged 600D PVC outside material
- > Padded 2cm foam inside
- > Easy folding and transport
- > Size L100xW48xH2cm (folded size L34xW48xH7cm)



| CODE     | TREF  | DESCRIPTION   | LENGTH | WIDTH | HEIGHT | SU | CTN QTY | RRP    |
|----------|-------|---------------|--------|-------|--------|----|---------|--------|
| 22400038 | T1108 | UNHOOKING MAT | 100CM  | 48CM  | 2CM    | 1  | 15      | €19.95 |



# NYTRO CRADLE

This Nytro branded cradle offers maximum protection for the fish when unhooking or when taking pictures. The cradle is manufactured using heavily padded nylon fabric for maximum protection, plus a 3cm foam mattress inside. The total size of the cradle is L100xW60xH22cm offering sufficient space and protection for the fish. The cradle comes with two webbing straps and a soft touch grip handle for transportation. Simply fold and zip-up to pack away and store.

- > Padded soft nylon material
- > Foam 3cm mattress inside
- > Fold and zip-up to stow-away and transport
- > Size L100xW60xH22cm (folded size L61xW48xH25cm)

| CODE     | TREF  | DESCRIPTION  | LENGTH | WIDTH | HEIGHT | SU | CTN QTY | RRP    |
|----------|-------|--------------|--------|-------|--------|----|---------|--------|
| 22400039 | T3886 | NYTRO CRADLE | 100CM  | 60CM  | 22CM   | 1  | 15      | €69.95 |





# ACCESSORIES



## EVA CONTINENTAL FEEDER RESTS

The Nytro EVA Continental Front Rests are designed for feeder fishing. They are available in two different sizes (30cm and 50cm), covering most feeder fishing requirements. This rest is manufactured from a high-density EVA material, offering maximum protection for your rods. Both rests are stable and feature a 45° upturned ripple side to prevent the rod from sliding along the rest in windy conditions or when undertow pulls the tip. The other side is straight so you can move your rod, pull on the line and move your feeder slightly, triggering fish to bite. The universal thread fits just about every feeder arm or bank stick. These feeder rests are easy to use and offer great value for money.

- > Stable front rest for feeder fishing
- > One 45° upturned rippled side
- > High-density EVA material
- > Colour black and red
- > Maximum stability and protection for your rod
- > Universal attachment thread
- > Available in two sizes (30 and 50cm)



| CODE     | TREF | DESCRIPTION                 | LENGTH | SU | CTN QTY | RRP    |
|----------|------|-----------------------------|--------|----|---------|--------|
| 21900001 | T719 | CONTINENTAL FEEDER REST 300 | 30CM   | 3  | 36      | €12.95 |
| 21900002 | T997 | CONTINENTAL FEEDER REST 500 | 50CM   | 3  | 27      | €17.95 |







# STEADY-REST

The Nytro Steady Rests are the ideal rod rests for just about all modern-day feeder fishing. The range consists of a variety of six front and rear rod rests. All models are double injection-moulded, ensuring a solid, rigid base, with soft moulded parts where rod needs most protection. The Nytro STEADY SLIDING RESTS are an industry-first and allow the angler to have the front and rear rest in any position.

## STEADY METHOD REST

This is the perfect rest for feeder fishing on commercials, the Nytro Steady Method Rest. Featuring a one-sided protruded sickle that prevents your rod from being yanked of the rest. You can lay your rod in multiple positions along the rest. All sections feature a small slot so you can make minor adjustments to the tension on the tip.

- > Method fishing rod rest
- > One sided protruded sickle safeguarding the rod on vicious takes
- > Four rod positions
- > Soft rubber grip surface
- > Slotted rod sections
- > Double-thread screw



| CODE     | TREF | DESCRIPTION        | SU | CTN QTY | RRP    |
|----------|------|--------------------|----|---------|--------|
| 21900003 | T831 | STEADY METHOD REST | 3  | 36      | €14.95 |

## STEADY SLIDING METHOD FRONT REST



You asked us to design a bigger Method Rest with a sliding function so it could be put in any position. That is exactly what we have done! A bigger, sliding rest for feeder fishing on commercials, the Nytro's Steady Sliding Method Rest. Featuring a one-sided protruded sickle that prevents your rod from being 'yanked' off the rest! You can now lay your rod in multiple positions along the rest and slide the base all the way left or right, to improve the angle on your feeder arm. All sections feature a small slot so you can make minor adjustments to the tension on the tip.

The Steady Sliding Method Rest allows you to fish two rods along side each other.

- > Large, sliding Method fishing rod rest
- > One sided protruded sickle safeguarding the rod on vicious takes
- > Ten rod positions
- > Soft rubber grip surface
- > Slotted rod sections
- > Double-thread screw



| CODE     | TREF  | DESCRIPTION                      | SU | CTN QTY | RRP    |
|----------|-------|----------------------------------|----|---------|--------|
| 20190009 | T1386 | STEADY SLIDING METHOD FRONT REST | 3  | 36      | €24.95 |



# STEADY ADJUSTABLE FRONT REST



The Nytro Steady Adjustable Sliding Front Rest is an industry-first front rest design. Incorporating an internal sliding system, allowing you to lock or set the rest in different positions, to both left or right. The rest features a soft rubber grip surface so the rod will not slip or damage. The Steady Rod Sliding Front Rest is designed with two, low raised edges, to position your rod against in windy conditions or in flowing waters. Fitted with two upright ends preventing the rod from shooting off the support when you have a bite.

- > Industry-first Steady Rod Sliding system
- > Soft rubber grip surface
- > Two low raised edges to position your rod against
- > Double thread screw

| CODE     | TREF  | DESCRIPTION                  | SU | CTN QTY | RRP    |
|----------|-------|------------------------------|----|---------|--------|
| 21900008 | T1108 | STEADY ADJUSTABLE FRONT REST | 3  | 36      | €19.95 |

# STEADY SLIDING MINI REST

The Nytro Steady Sliding Mini Rest is an industry-first where adjustable rests are concerned. We have designed this as a back rest allowing precise positioning of your rod butt. This enables you to move your rod slightly, to release or increase the tension on your rod tip without moving the feeder.

The Steady Sliding Mini Rest can also be used as a mini front rest. The uprights on both sides prevent the rod from being pulled off the rest.

The rest is fixed in position under pressure from the universal screw thread, so when you tighten the rest, it remains in the selected position.



- > Industry-first Steady Rod Sliding system
- > Versatile front or rear rest
- > Soft rubber grip surface
- > Ideal to release or add pressure to your rod tip
- > Double thread screw
- > Uprights on both sides preventing the rod from being pulled off

| CODE     | TREF | DESCRIPTION              | SU | CTN QTY | RRP    |
|----------|------|--------------------------|----|---------|--------|
| 21900005 | T942 | STEADY SLIDING MINI REST | 3  | 36      | €16.95 |

# STEADY ADJUSTABLE BUTT REST

The Nytro Steady Adjustable Butt Rest is an industry-first where adjustable back rests are concerned. We have designed this versatile back rest not only to precisely position your rod, but also to allow you to move your rod to release, or increase the tension on your rod tip, without moving the feeder. You can fix the rest with the universal screw-fitting under the butt grip, or you can leave it loose so you can constantly adjust, according to the circumstances. These rests are ideal in both still and flowing water conditions. The butt grip is designed to hold rods with varying handle diameters. The duo-level allows the rod to be loosely positioned in the top or pushed downward into the base for extra grip. The soft grip material allows the rod to be held firmly in place when needed, while still allowing a quick release of the rod when you get a bite or when you need to cast again. Perfect when fishing on higher banks where your rod points downwards and you need extra grip



- > Industry-first Steady Rod Sliding system
- > Adjustable duo-level butt rest
- > Soft rubber grip surface
- > Double-thread screw

| CODE     | TREF  | DESCRIPTION                 | SU | CTN QTY | RRP    |
|----------|-------|-----------------------------|----|---------|--------|
| 21900007 | T1108 | STEADY ADJUSTABLE BUTT REST | 3  | 36      | €19.95 |

## STEADY SLIDING DOUBLE DUO BACK REST



You see more and more feeder anglers, fish two rods. And when we launched the Steady Sliding Duo Butt Grip you asked us to design one that would hold two rods. Which is what we did with this industry-first Steady Sliding Double Duo Back Rest.

We have designed this versatile back rest not only to precisely position one or two rods, but also to allow you to move your rod slightly to release, or increase the tension on your rod tip, without moving the feeder. You can fix the rest with the universal screw-fitting under the butt grip, or you can leave it loose so you can constantly adjust, according to the circumstances.

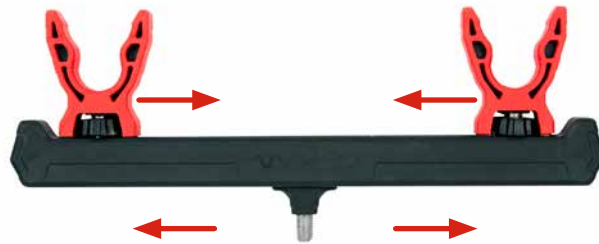

The butt grips are designed to hold rods with varying handle diameters. The duo-level allows rods to be loosely positioned in the top or pushed downward into the base for extra grip. The soft grip material allows the rods to be held firmly in place when needed, while still allowing a quick release of the rods when you get a bite or when you need to cast again. Perfect when fishing on higher banks where your rod points downwards and you need extra grip.

This backrest is also ideal when fishing a sleeper-rod when practice fishing.

- > Industry-first STEADY REST sliding system
- > Two-rod positioning adjustable duo-level butt rests
- > Soft rubber grip surface
- > Double-thread screw

| CODE     | TREF  | DESCRIPTION                         | SU | CTN QTY | RRP    |
|----------|-------|-------------------------------------|----|---------|--------|
| 20190010 | T1386 | STEADY SLIDING DOUBLE DUO BACK REST | 3  | 36      | €24.95 |

## STEADY DUO BUTT REST

The Nytro Steady Duo Butt Rest is designed to hold rods with varying handle diameters. The duo-level allows the rod to be loosely positioned in the top or pushed down for extra grip. The soft grip material allows the rod to be held firmly in place when needed, while still allowing quick release when you get a bite or when you need to cast again. Ideal for use when fishing on higher banks where your rod points downwards and you need extra grip.

- > Duo-level butt rest
- > Soft rubber grip surface
- > Double thread screw



| CODE     | TREF | DESCRIPTION          | SU | CTN QTY | RRP   |
|----------|------|----------------------|----|---------|-------|
| 21900006 | T497 | STEADY DUO BUTT REST | 3  | 108     | €8.95 |

## STEADY U-REST

The Nytro Steady U-Rest is truly versatile and will fit most rod handle sizes. It has a soft rubber inlay which prevents damage to the rod or landing net handle. It can be used as a rear or front rest.

- > Versatile front/rear rest
- > Soft rubber grip surface
- > Ideal to keep your landing net in place in windy conditions
- > Double-thread screw



| CODE     | TREF | DESCRIPTION   | SU | CTN QTY | RRP   |
|----------|------|---------------|----|---------|-------|
| 21900004 | T497 | STEADY U-REST | 3  | 108     | €8.95 |





# KLIP ON

Klip-On is a product you did not even know you needed until you've seen it! They simply attach to your bait tub, EVA-tub or on to a 19mm edge of a side tray. Manufactured from soft latex material, they are lightweight and easy to use. We designed these with strong but flexible material, so Klip-Onz fit on virtually all bait and EVA tubs.

- > Extremely versatile
- > Strong and flexible
- > Ideal for saving space and staying organized

## KLIP-ON HANDLE & ROD REST

A very handy Klip-On for every 19mm side tray upright. It will hold your landing net handle, and top kits or rod handles as well. The strong but flexible material allows rod handles and tops kits to be fixed without damaging them. A perfect and extremely versatile product in the Klip-On range.

- > Extremely versatile
- > Strong and flexible
- > Ideal for saving space and staying organized
- > Fits most rod handles, landing net handles and pole top kits



| CODE     | TREF | DESCRIPTION               | SU | CTN QTY | RRP   |
|----------|------|---------------------------|----|---------|-------|
| 22000004 | T442 | KLIP-ON HANDLE & ROD REST | 3  | 36      | €7.95 |

## KLIP-ON BAIT TRAY

Do you have trouble leaving pre-baited hooklengths on your side tray and then losing them? So did we! Do we designed a Klip-On Bait Tray that safeguards them and gives them a dedicated place on your side tray. We also added some holes to store your baiting needles and drills, right where you need them.

- > Extremely versatile
- > Strong and flexible
- > Ideal for saving space and staying organized
- > Fits just about every bait and EVA tub
- > Five dishes for pre-baited hooklengths
- > Cavities for baiting needle and bait drill



| CODE     | TREF | DESCRIPTION             | SU | CTN QTY | RRP   |
|----------|------|-------------------------|----|---------|-------|
| 22000002 | T442 | NYTRO KLIP-ON BAIT TRAY | 3  | 36      | €7.95 |

## KLIP-ON CHOPPER HOLDER

So many of us use a worm chopper but where to put it? Put the Klip-On Chopper Holder on your bait tray or EVA-tub and you always have a dedicated position for it. Is also features space for a baiting needle, a small disgorger, bait drills and even some hooklengths that are ready to be used.

- > Extremely versatile
- > Strong and flexible
- > Ideal for saving space and staying organized
- > Fits just about every bait and EVA tub
- > Cavity for worm chopper
- > Cavities for baiting needle and bait drill or small disgorger
- > Five slits to safeguard hooklengths, ready to use



| CODE     | TREF | DESCRIPTION            | SU | CTN QTY | RRP   |
|----------|------|------------------------|----|---------|-------|
| 22000001 | T442 | KLIP-ON CHOPPER HOLDER | 3  | 36      | €7.95 |



## KLIP-ON DIP TRAY

Do you use bait dips? They are often standing here or there but never in the same place. We recognized that and have designed a Klip-On Dip Tray that will hold a multitude of different sizes. If you use more than one, just add more to your bait tub or EVA-tub to keep them neatly together. They also fit most pots/tubs with bandums, sinkers, mini boilies and wafers.

- > Extremely versatile
  - > Strong and flexible
  - > Ideal for saving space and staying organized
  - > Fits just about every bait and EVA tub
- > Cavity for most bottles and pots with flavours and dips
  - > Fits most tubs with bandums, sinkers, mini boilies and wafers
  - > Cavities for baiting needles and bait drills



| CODE     | TREF | DESCRIPTION      | SU | CTN QTY | RRP   |
|----------|------|------------------|----|---------|-------|
| 22000003 | T497 | KLIP-ON DIP TRAY | 3  | 36      | €8.95 |

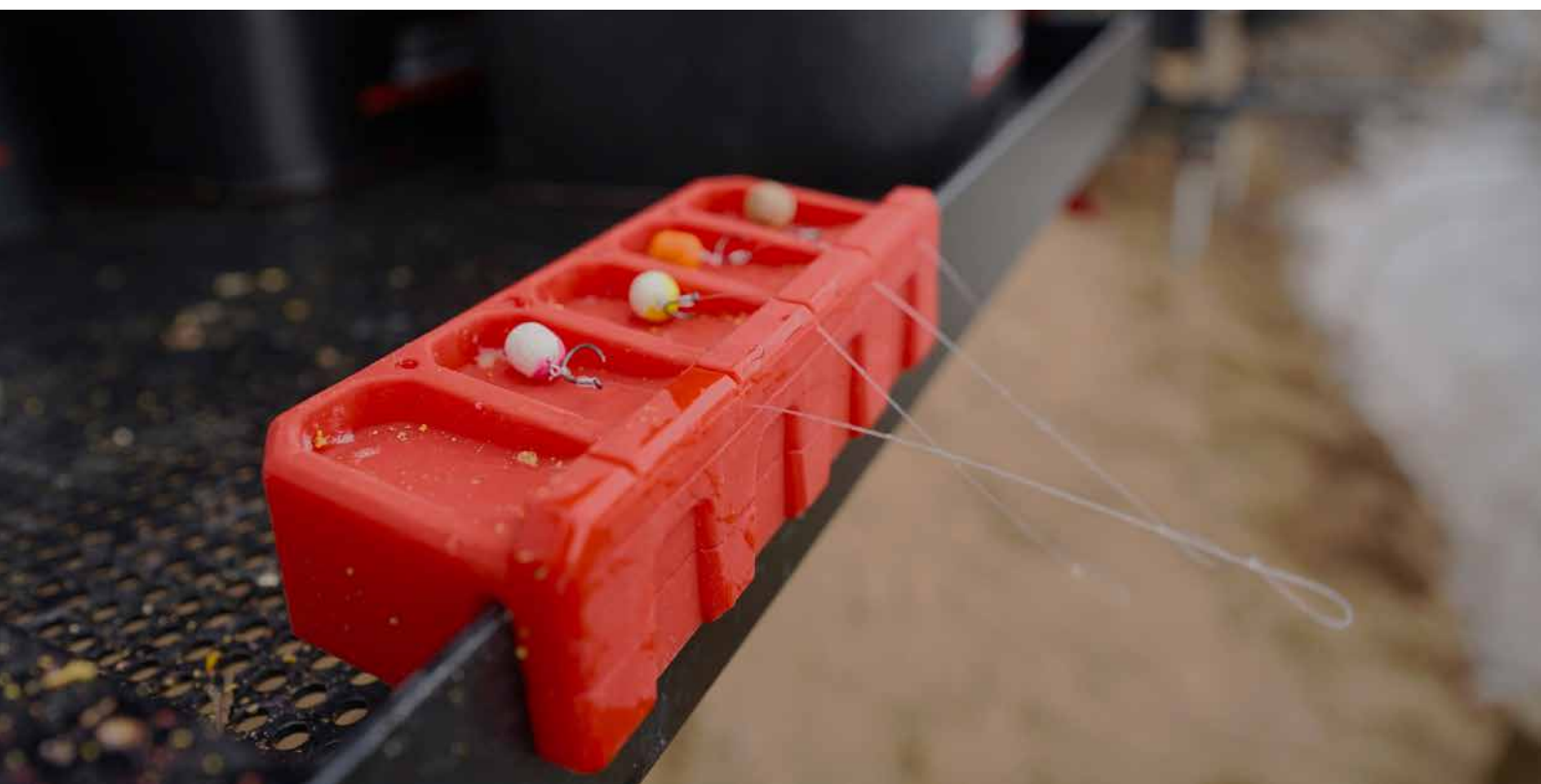



COMNEX



# CONNEX

Introducing the Nytro CONNEX range of feeder swivels, precision engineered to redefine your feeder fishing experience. With an unwavering commitment to quality, the Nytro CONNEX range of swivels offers high quality, supreme strength, and durability. Each individual swivel is crafted using cutting-edge materials such as copper and stainless steel and a precision manufacturing processes, ensuring optimal performance and reliability. Whether you are casting long distances and fishing for carp or bream, or you are finesse fishing for skimmers or roach, Nytro CONNEX swivels provide a seamless connection, minimizing line twist and maximizing your catch rate. Explore our new range to discover the perfect swivel that suits your style of fishing and experience the difference that Nytro CONNEX swivels have to offer.

And one more thing... our products are packed with less plastic and more planet-friendly packaging.



NEW

## QUICK CHANGE FEEDER SWIVELS 8 PER PACK



NEW

## MIXED-EYE MINI FEEDER SWIVEL 14 20 PER PACK



Our Quick-Change Feeder Swivels are manufactured in four popular sizes. Their use makes it easy to change hooklengths quickly when you are fishing with a feeder or a pellet waggler. These swivels are high-quality and help prevent the hook link from twisting or getting tangled. We use the best materials we can find and precision manufacturing to make sure these swivels are consistent and continue to perform.

| CODE     | TREF | SIZE | BREAKING STRENGTH | SU | CTN QTY | RRP   |
|----------|------|------|-------------------|----|---------|-------|
| 22100001 | T144 | 14   | 4LBS              | 10 | 500     | €2.59 |
| 22100002 | T144 | 12   | 7LBS              | 10 | 500     | €2.59 |
| 22100003 | T144 | 10   | 9LBS              | 10 | 500     | €2.59 |
| 22100004 | T144 | 8    | 14LBS             | 10 | 500     | €2.59 |

Mixing round and diamond eyes on a swivel offers a unique blend of advantages for the modern feeder angler. Combining the best features of both designs to enhance fishing efficiency and performance. The round eye is ideal for simple knot connections, while the diamond eye provides a snugger fit for thinner lines. The mini swivel 14 has been developed to create a link between the main line and a hook link and can be used to reduce line twist.

| CODE     | TREF | SIZE | BREAKING STRENGTH | SU | CTN QTY | RRP   |
|----------|------|------|-------------------|----|---------|-------|
| 22100005 | T127 | 14   | 4LBS              | 10 | 500     | €2.29 |



NEW

## MIXED-EYE FEEDER SWIVELS 10 PER PACK



NEW

## DOUBLE FEEDER SWIVEL WITH HOOKED SNAP 10 PER PACK



These Mixed-eye Rolling Feeder Swivels are available in two of the most popular sizes, 8 and 10. Mixing round and diamond eyes on a swivel offers a unique blend of advantages for the modern feeder angler. Combining the best features of both designs to enhance fishing efficiency and performance. The round eye is ideal for simple knot connections, while the diamond eye provides a snugger fit for thinner lines. These swivels are ideal to avoid any sort of line tangle.

| CODE     | TREF | SIZE | BREAKING STRENGTH | SU | CTN QTY | RRP   |
|----------|------|------|-------------------|----|---------|-------|
| 22100006 | T099 | 10   | 9LBS              | 10 | 500     | €1.79 |
| 22100007 | T099 | 8    | 14LBS             | 10 | 500     | €1.79 |

Featuring a double-barrel design, these swivels provide superior anti-twist functionality, making them ideal for changing any leader or feeder cage very quickly. The inclusion of a hooked snap ensures exceptional durability, making these swivels perfectly suited for long-distance casting.

| CODE     | TREF | SIZE | BREAKING STRENGTH | SU | CTN QTY | RRP   |
|----------|------|------|-------------------|----|---------|-------|
| 22100008 | T166 | 10   | 12LBS             | 10 | 500     | €2.99 |
| 22100009 | T166 | 8    | 12LBS             | 10 | 500     | €2.99 |
| 22100010 | T166 | 6    | 20LBS             | 10 | 500     | €2.99 |



NEW

### FEEDER SWIVEL WITH SAFETY SNAP 10 PER PACK

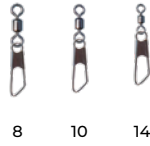

These lightweight rolling swivels with safety snap links are designed for rapid changing of rigs and swivels. Their design allows for a slick and minimalistic set-up. These swivels feature a strong stainless-steel safety snap link, that is easy to open and close, over and over again.

| CODE     | TREF | SIZE | BREAKING STRENGTH | SU | CTN QTY | RRP   |
|----------|------|------|-------------------|----|---------|-------|
| 22100011 | T099 | 14   | 4LBS              | 10 | 500     | €1.79 |
| 22100012 | T099 | 10   | 7LBS              | 10 | 500     | €1.79 |
| 22100013 | T099 | 8    | 7LBS              | 10 | 500     | €1.79 |



NEW

### SLIDING FEEDER BEAD WITH HOOKED SNAP SMALL 8 PER PACK



This finesse Sliding Feeder Bead, equipped with a hooked snap link, facilitates smooth movement along your mainline. Its user-friendly design allows for quick and easy changing of a feeder or bomb weight. Ideal for a lightweight set-up.

| CODE     | TREF | SIZE  | SU | CTN QTY | RRP   |
|----------|------|-------|----|---------|-------|
| 22100014 | T177 | SMALL | 10 | 500     | €3.19 |

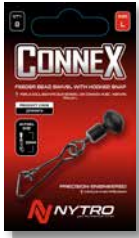

NEW

### FEEDER BEAD SWIVEL WITH HOOKED SNAP LARGE 8 PER PACK



The Connex Feeder Bead, equipped with a powerful hooked snap link, allows optimal movement along your mainline. The hooked snap allows for quick and easy changing of a feeder or bomb weight. Ideal for circumstances that demand medium to long distance casting.

| CODE     | TREF | SIZE  | SU | CTN QTY | RRP   |
|----------|------|-------|----|---------|-------|
| 22100015 | T166 | LARGE | 10 | 500     | €2.99 |



NEW

### SLIDING FEEDER BEAD WITH SAFETY SNAP LARGE 8 PER PACK



The Connex Feeder Bead, equipped with a finesse safety snap link, allows optimal movement along your mainline. The safety snap allows for quick and easy changing of a feeder or bomb weight, time and time again. Ideal for circumstances that ask for short to medium range distance casting or a lightweight set-up.

| CODE     | TREF | SIZE  | SU | CTN QTY | RRP   |
|----------|------|-------|----|---------|-------|
| 22100016 | T166 | LARGE | 10 | 500     | €2.99 |



NEW

### STIFF FEEDER LINK 2 PER PACK



The Connex Stiff Feeder Links are specifically designed for fishing with a free-running rig. Thanks to the stiff fluorocarbon material, the hook link will rarely get tangled. Incorporating the Connex Sliding Feeder Bead, allows the Stiff Feeder Link to slide effortlessly over the mainline. These Stiff Feeder Links come in two 0.45mm Fluorocarbon links with a safety snap for up to medium-heavy and two 0.60mm Fluorocarbon links with a hooked snap for long range and fishing with heavy feeder.

| CODE     | TREF | SIZE       | SU | CTN QTY | RRP   |
|----------|------|------------|----|---------|-------|
| 22100020 | T166 | 2.4" (6CM) | 10 | 500     | €2.99 |
| 22100021 | T166 | 3" (7.5CM) | 10 | 500     | €2.99 |
| 22100022 | T183 | 2.4" (6CM) | 10 | 500     | €3.29 |
| 22100023 | T183 | 3" (7.5CM) | 10 | 500     | €3.29 |



NEW

### FEEDERGUM LINK 3 PC X 10 PER PACK

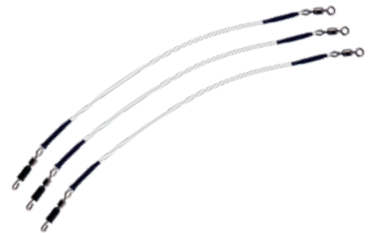

The Nytro Feeder Gum Links feature high-quality Connex swivels, a rolling swivel on one end and a quick-change swivel on the other end and black heat-shrink tubing to neatly finish it off. Feeder Gum Links are available in 4" (10 cm) and 6" (15 cm) versions, with the Power Gum having a diameter of 0.8 mm. Each pack contains three links.

| CODE     | TREF | SIZE    | SU | CTN QTY | RRP   |
|----------|------|---------|----|---------|-------|
| 22100028 | T177 | 4"/10CM | 10 | 1000    | €3.19 |
| 22100029 | T177 | 6"/15CM | 10 | 1000    | €3.19 |





NyTRO's Free Running Swivel Blockers come in two sizes, medium and large. They are the ideal solution for tying a sliding feeder rig where it blocks a sliding swivel, or a Sliding Feeder Bead on the mainline to create a natural boom. Especially when you twist the line and pull the knot inside the Blocker Bead.

| CODE     | TREF | SIZE   | SU | CTN QTY | RRP   |
|----------|------|--------|----|---------|-------|
| 22100110 | T111 | MEDIUM | 10 | 500     | €1.99 |
| 22100111 | T111 | LARGE  | 10 | 500     | €1.99 |



These oval rubber Feeder Blocker Stops are suitable for braid and mono lines and come in three different sizes, small – medium – large. This makes them ideal for a wide variety of fishing techniques. The soft material construction prevents damage to your mainline and with the variety of sizes that cover finesse to distance casting set-ups.

| CODE     | TREF | SIZE   | SU | CTN QTY | RRP   |
|----------|------|--------|----|---------|-------|
| 22100112 | T111 | SMALL  | 10 | 500     | €1.99 |
| 22100113 | T111 | MEDIUM | 10 | 500     | €1.99 |
| 22100114 | T111 | LARGE  | 10 | 500     | €1.99 |



These silicone Protector Stops come in three different sizes, small – medium – large. This makes them ideal for covering knots and even over the eye of a swivel to protect knots and prevent line damage. The shape has been designed so swivels continue to run freely.

| CODE     | TREF | SIZE   | SU | CTN QTY | RRP   |
|----------|------|--------|----|---------|-------|
| 22100115 | T111 | SMALL  | 10 | 500     | €1.99 |
| 22100116 | T111 | MEDIUM | 10 | 500     | €1.99 |
| 22100117 | T111 | LARGE  | 10 | 500     | €1.99 |



Stopitz are the perfect line stoppers, supplied on a metal wire for trouble-free application. They slide effortlessly onto your line to secure wagglers or feeders in place. The unique profile of Stopitz ensures they sit straight on your line, creating a streamlined setup. Being slightly longer than conventional stoppers and featuring flattened ends, they are ideal for tying running rigs for feeder fishing. When the feeder hits the stopper, it creates the perfect boom!

| CODE     | TREF | SIZE  | SU | CTN QTY | RRP   |
|----------|------|-------|----|---------|-------|
| 22100034 | T125 | LARGE | 10 | 1000    | €2.25 |



The NyTRO Wagglers Kit is ideal for securely attaching loaded Pellet Wagglers to your main line without using shot, which can often damage the line and cause lost fish. To assemble, move the line stoppers one at a time onto your line as the Stopitz are designed to be tight. Once on your line, simply adjust each stopper to the desired position for the perfect waggler setup. Each pack contains five sets.

| CODE     | TREF | SIZE | SU | CTN QTY | RRP   |
|----------|------|------|----|---------|-------|
| 22100035 | T153 | *    | 10 | 1000    | €2.75 |



The Stopitz Helicopter Kit is a quick and uncomplicated way to set up a ready-to-use version of this popular feeder rig! Featuring a Connex quick-change swivel for your hooklength and two Stopitz rubber stoppers on each side. Simply thread your main line through the loop and slide the Stopitz and swivel onto your main line. Each pack contains five sets.

| CODE     | TREF | SIZE | SU | CTN QTY | RRP   |
|----------|------|------|----|---------|-------|
| 22100036 | T177 | *    | 10 | 1000    | €3.19 |



**NYTRO HI-CARBON STEEL BARBED METHOD BAIT SPIKE 7.5MM**  
10 PER PACK



Using these 7.5mm barbed, lightweight, hi-carbon bait spikes, is the easiest and quickest way when fishing with small hook baits.

| CODE     | TREF | SIZE  | SU | CTN QTY | RRP   |
|----------|------|-------|----|---------|-------|
| 22100017 | T138 | 7.5MM | 10 | 500     | €2.49 |



**NYTRO STAINLESS STEEL TWISTED METHOD BAIT SPIKE 8MM**  
9 PER PACK



Using these 8mm twisted, hardwearing stainless steel bait spikes, is the easiest and quickest way for fishing with 6-10mm hook baits such as boilies and dumbbells. The twist-design ensures the bait is held securely in place.

| CODE     | TREF | SIZE | SU | CTN QTY | RRP   |
|----------|------|------|----|---------|-------|
| 22100018 | T155 | 8MM  | 10 | 500     | €2.79 |



**FEEDERLINK STILLWATER**  
1 SET/ PER PACK



Nytro's transparent Low-Viz Quick-Stops are strong and enable quick and easy changes of hook bait. Ideal for corn, mini boilies, wafers, meat and worm.

| CODE     | TREF | SIZE   | SU | CTN QTY | RRP   |
|----------|------|--------|----|---------|-------|
| 22100118 | T055 | SMALL  | 10 | 500     | €0.99 |
| 22100119 | T055 | MEDIUM | 10 | 500     | €0.99 |



**QUICK CHANGE CONNECTOR BEAD SMALL**  
3 PC X 10 PER PACK

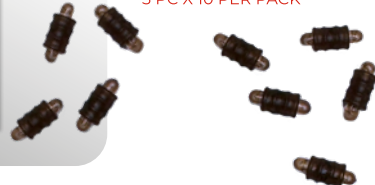

The Nytro Quick-Change Connector Bead is designed for quick hook length changes when Method feeder fishing. Once the loops are attached to the connector, the rubber shield covers it completely, ensuring it is securely stored.

| CODE     | TREF | SIZE  | SU | CTN QTY | RRP   |
|----------|------|-------|----|---------|-------|
| 22100120 | T153 | SMALL | 10 | 500     | €2.75 |
| 22100121 | T153 | LARGE | 10 | 500     | €2.75 |



# FEEDERLINK



ACCESSORIES

NYTRO

A series of four of the most popular ready-to-use feeder link systems. Precision tied with high quality mono incorporating Nytro's Connex swivels and stoppers. Looped on one side so you can use straight from the package and easily to connect it to your mainline.

- > Ready to use
- > Precision tied
- > Quality monofilament
- > Connex swivels and stoppers

## FEEDERLINK ALLROUND NEW

2PCS PER PACK

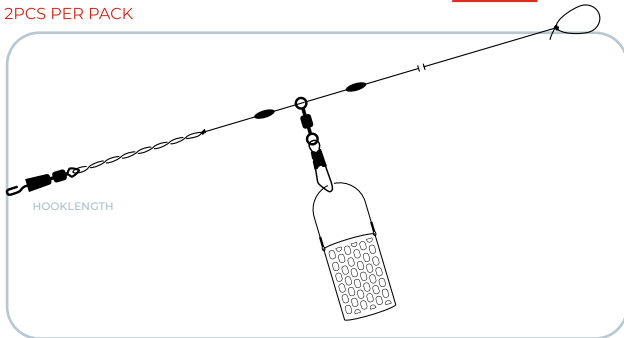

Tied with a safety snap for your feeder cage and a quick-change swivel on a twizzled boom to attach your hook length, keeping it away from your feeder. With two stoppers you can fish this rig as a bolt or semi-bolt rig system. Generally used with an open-end feeder cages.

| CODE     | TREF | SIZE | SU | CTN QTY | RRP   |
|----------|------|------|----|---------|-------|
| 22100030 | T194 | *    | 10 | 1000    | €3.49 |

## FEEDERLINK STILLWATER NEW

2PCS PER PACK

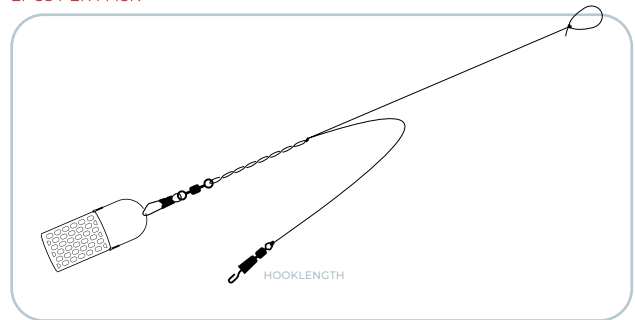

Typical, minimalistic and easy to use stillwater feeder link. Tied with a safety snap swivel on a twizzled boom and a quick-change swivel for your hooklength on a kicker side line, keeping your hooklength away from the feeder. Generally used with an open-end feeder cage, bullet or window feeder.

| CODE     | TREF | SIZE | SU | CTN QTY | RRP   |
|----------|------|------|----|---------|-------|
| 22100031 | T194 | *    | 10 | 1000    | €3.49 |

## FEEDERLINK RUNNING WATER NEW

2PCS PER PACK

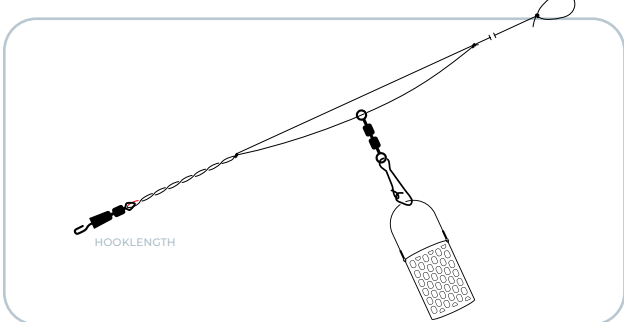

A standard feeder link which is simple, super effective and above all it hardly ever gets tangled. The big advantage is that the fish does not feel any resistance when picking up the bait, so when the conditions are tough and the fish are shy, this is the system to use. Simply attach your feeder to the hooked snap swivel, your hooklength to the quick-change swivel and off you go!

| CODE     | TREF | SIZE | SU | CTN QTY | RRP   |
|----------|------|------|----|---------|-------|
| 22100032 | T194 | *    | 10 | 1000    | €3.49 |

## FEEDERLINK HELICOPTER NEW

2PCS PER PACK

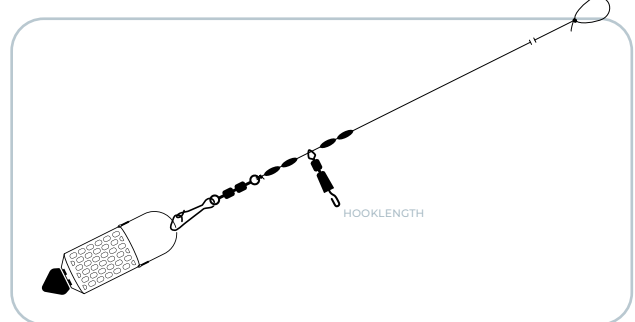

The perfect Helicopter rig, ready from the packet. Simply attach it to your mainline, put a feeder on the hooked snap swivel and attach a hooklength on the quick-change swivel. The quick-change swivel sits between a set of stoppers so you can adjust the height.

| CODE     | TREF | SIZE | SU | CTN QTY | RRP   |
|----------|------|------|----|---------|-------|
| 22100033 | T194 | *    | 10 | 1000    | €3.49 |



# NYTRO NEEDLE

## NYTRO FLOATING HINGED BAITING NEEDLE NEW

The Nytro Floating Hinged Baiting Needle is equipped with a stainless steel flattened needle, with a clip-hook for quick and easy hair rigging. Ideal for (mini) boilies and wafers and also softer bait such as corn and meat. This needle is designed with a sturdy handle that feels comfortable and is made of a floating material, so it remains buoyant if it falls into the water.

| CODE     | TREF | SIZE | QTY/PACK | SU | CTN QTY | RRP   |
|----------|------|------|----------|----|---------|-------|
| 22100100 | T138 | 9CM  | 1PC      | 10 | 500     | €2.49 |



## NYTRO FLOATING HOOKED NEEDLE NEW

The Floating Hooked Needle has been developed for pulling a hair or bait band through, soft pellet, corn, soft hook baits or even live-bait such as a worms. This needle is designed with a sturdy handle that feels comfortable and is made of a floating material, so it remains buoyant if it falls into the water.

| CODE     | TREF | SIZE | QTY/PACK | SU | CTN QTY | RRP   |
|----------|------|------|----------|----|---------|-------|
| 22100101 | T138 | 8CM  | 1PC      | 10 | 500     | €2.49 |



## NYTRO FLOATING BAIT DRILL NEW

The Floating Bait Drill is a handy tool for drilling holes in (mini) boilies, wafers and pellets. Designed with a sturdy handle that feels comfortable and made of a floating material, so it remains buoyant if it falls into the water.

| CODE     | TREF | SIZE | QTY/PACK | SU | CTN QTY | RRP   |
|----------|------|------|----------|----|---------|-------|
| 22100102 | T138 | 8CM  | 1PC      | 10 | 500     | €2.49 |



## NYTRO FLOATING HOOKED NEEDLE NEW

The Nytro Floating Quick Stop Needle is a handy tool for hair rigging baits with a quick-stop. This needle is designed with a sturdy handle that feels comfortable and is made of a floating material, so it remains buoyant if it falls into the water.

| CODE     | TREF | SIZE | QTY/PACK | SU | CTN QTY | RRP   |
|----------|------|------|----------|----|---------|-------|
| 22100103 | T138 | 9CM  | 1PC      | 10 | 500     | €2.49 |



## FLOATING SUPER FINE BAITING NEEDLE NEW

The Nytro super-fine baiting needles are meticulously crafted to minimize damage to delicate hook baits when hair rigging. The fine, stainless-steel needle features a recessed barb and tapered point for precision. Ideal for (mini) boilies and wafers and softer bait such as corn, meat and live bait. This needle is designed with a flared rounded handle that provides a secure grip, allowing you to apply the necessary pressure to penetrate harder baits without slipping. Made from a floating material, so it stays buoyant if it falls into the water.

| CODE     | TREF | SIZE | QTY/PACK | SU | CTN QTY | RRP   |
|----------|------|------|----------|----|---------|-------|
| 22100104 | T138 | 8CM  | 1PC      | 10 | 500     | €2.49 |

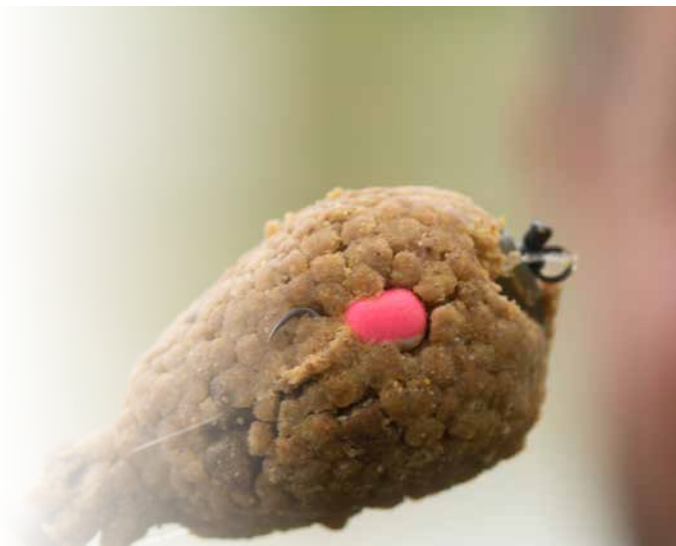

# STARKX FS TACKLE BOXES

Tired of messy bags and losing your gear? The StarkX FS Tackle Boxes are the solution! The range contains six models in a variety of shapes, sizes and function, to help you store your feeder gear in an orderly manner. Whether storing your feeders and accessories by type at home, or bringing a selection to the bank, we have the right box to suit.

## STARKX FS DELUXE FEEDER BOX 380

This top of the range, high quality feeder box offers the space for not just feeders, but also smaller accessories such as swivels, beads etc. The many dividers allow you to create multiple sections, large and small, narrow and wide. The ideal all-in-one storage system.

- > Designed for feeder anglers
- > Strong ABS plastic
- > Conveniently arranged
- > Removable compartments
- > Great for storing feeder gear at home or to bring to the bank



| CODE     | TREF  | DESCRIPTION                     | SIZE             | SU | CTN QTY | RRP    |
|----------|-------|---------------------------------|------------------|----|---------|--------|
| 22000010 | T1942 | STARKX FS DELUXE FEEDER BOX 380 | 380 x 300 x 60MM | 1  | 15      | €34.95 |

## STARKX FS DOUBLE FEEDER BOX 360

This double layer tackle box is designed for feeder anglers. The two layers offer lots of space for all your feeders and accessories. The tackle box is conveniently arranged with additional dividers to store all your gear in an orderly manner.

- > Designed for feeder anglers
- > Double layer box
- > Strong ABS plastic
- > Gunsmoke transparent lid
- > Conveniently arranged
- > Removable compartments
- > Great for storing feeder gear at home or to bring to the bank



| CODE     | TREF  | DESCRIPTION                     | SIZE             | SU | CTN QTY | RRP    |
|----------|-------|---------------------------------|------------------|----|---------|--------|
| 22000011 | T1108 | STARKX FS DELUXE FEEDER BOX 360 | 360 x 230 x 70MM | 1  | 25      | €19.95 |

## STARKX FS FEEDER BOX MS275-S

Medium size tackle box, ideal for smaller feeders and accessories such as swivels, beads, stem kits etc.

- > Designed for feeder anglers
- > Strong ABS plastic
- > Gunsmoke transparent lid
- > Waterproof seal
- > Conveniently arranged
- > Removable compartments
- > Great for storing feeder gear at home or to bring to the bank



| CODE     | TREF | DESCRIPTION                  | SIZE             | SU | CTN QTY | RRP   |
|----------|------|------------------------------|------------------|----|---------|-------|
| 22000012 | T553 | STARKX FS FEEDER BOX MS275-S | 275 x 180 x 50MM | 1  | 36      | €9.95 |



## STARKX FS FEEDER BOX LS355-S

Large size tackle box, ideal for storing feeders and accessories such as swivels, beads, stem kits etc.

- > Designed for feeder anglers
- > Strong plastic
- > Gunsmoke transparent lid
- > Waterproof seal
- > Conveniently arranged
- > Removable compartments
- > Great for storing feeder gear at home or to bring to the bank



| CODE     | TREF | DESCRIPTION                  | SIZE             | SU | CTN QTY | RRP    |
|----------|------|------------------------------|------------------|----|---------|--------|
| 22000013 | T719 | STARKX FS FEEDER BOX LS355-S | 355 x 230 x 50MM | 1  | 30      | €12.95 |

## STARKX FS FEEDER BOX LD355-D

Large, deep tackle box, ideal for storing longer and bigger feeders, such as bullet feeders, window feeders and bait-up feeders.

- > Designed for feeder anglers
- > Strong plastic
- > Gunsmoke transparent lid
- > Waterproof seal
- > Conveniently arranged
- > Removable compartments
- > Great for storing feeder gear at home or to bring to the bank



| CODE     | TREF | DESCRIPTION                  | SIZE             | SU | CTN QTY | RRP    |
|----------|------|------------------------------|------------------|----|---------|--------|
| 22000014 | T886 | STARKX FS FEEDER BOX LD355-D | 355 x 230 x 92MM | 1  | 15      | €15.95 |

## STARKX FS FEEDER RIG STORE BOX 300

The StarkX Feeder Rig Store Box is ideal for keeping your hooklengths and shock leaders neatly packed together. The box contains 24 EVA spools with pins to secure your rigs, all printed in white so you can mark and remember which line diameter, rig length, hook model and size. The EVA spools protect the hook point and prevent the line from getting kinked or damaged.

- > Designed for feeder anglers
- > Strong plastic
- > Gunsmoke transparent lid
- > 24 EVA spools included (offering space to safely store at least 240 hooklengths)
- > Supplied with 24 pins to securely fix your feeder rigs
- > Conveniently arranged
- > Removable compartments
- > Great for storing feeder gear at home or to bring to the bank



| CODE     | TREF | DESCRIPTION                        | SIZE             | SU | CTN QTY | RRP    |
|----------|------|------------------------------------|------------------|----|---------|--------|
| 22000015 | T997 | STARKX FS FEEDER RIG STORE BOX 300 | 300 x 120 x 75MM | 1  | 6       | €17.95 |



## BRAID & MONO SCISSORS



These high-quality braid and mono scissors feature an improved design with high-quality Teflon coated stainless steel serrated blades. They also feature an ergonomic, non-slip black TPR handle with a soft-touch finish. Ideal for cutting PE/braided and mono lines, even without tension.



- > PE/Braid line cutter
- > Teflon coating
- > Stainless steel serrated blades
- > Non-slip TPR handle

| CODE     | TREF | DESCRIPTION           | SU | CTN QTY | RRP   |
|----------|------|-----------------------|----|---------|-------|
| 22000030 | T553 | BRAID & MONO SCISSORS | 5  | 500     | €9.95 |

## DISTANCE STICKS ALUMINIUM



Distance sticks are essential for measuring the distance to your chosen spot, ensuring you consistently cast your bait and rigs in the same position every time. These 81cm sticks feature a strong and lightweight aluminum construction with a durable, sharp stainless steel ground screw. They come complete with one 3m and one 6m measuring cord for precise measurements. Each stick is equipped with a translucent red endcap and a built-in Tommy bar for use in hard-ground situations. Grooves on the sticks prevent line or braid from spilling off when being wrapped.

- > Strong and lightweight aluminum construction
- > Durable, sharp stainless-steel ground screw
- > 3m and 6m measuring cords included
- > Red end caps with built in Tommy bars
- > Grooves to prevent line spillage
- > Comes with a transport pouch



| CODE     | TREF  | DESCRIPTION           | SU | CTN QTY | RRP    |
|----------|-------|-----------------------|----|---------|--------|
| 20700010 | T2219 | BRAID & MONO SCISSORS | 1  | 20      | €39.95 |

## BAIT WHIZZA



The Nytro Bait Whizza offers a quick solution to chopping bait quickly and efficiently. Useful for chopping worms, maggots, corn and other soft texture bait. Designed with three razor sharp blades, the Whizza chops bait up quickly, giving you more time to fish. Compact design and very easy to use and clean.



- > Bait chopper
- > Suitable for worms, maggots, corn and luncheon meat
- > Easy to use
- > Easy to clean
- > Time-saving

| CODE     | TREF | DESCRIPTION | SU | CTN QTY | RRP    |
|----------|------|-------------|----|---------|--------|
| 20700015 | T608 | BAIT WHIZZA | 1  | 36      | €10.95 |



# TARGETZ

- > Three sizes S – M – L, in various weights
- > Designed in close cooperation with Tommy Pickering
- > High-grade plastic body lifts faster on retrieve than a wire cage feeder avoiding obstacles on the bottom
- > Custom designed for precise long-distance casting
- > Precision engineered rounded holes, enhancing bait release and improving water flow
- > Aerodynamic placement of the weight for added distance casting
- > Maximum water flow to minimize resistance in the water on the retrieve
- > Supreme bait presentation
- > Ideal for a wide variety of different bait
- > Lead free



## TARGETZ BULLET FEEDERS

These lead-free Targetz Bullet Feeders are totally different! They are available in three sizes, small – medium and large and come in a variety of popular casting weights. As a result of the specific placement of the bullet weight, Targetz Bullet Feeders cast further, fly straighter and cause less resistance on the retrieve. The precision designed holes allow for a better water flow, making them ideal for delivering and releasing a variety of different bait. Targetz Bullet Feeders offer supreme bait presentation.

| CODE     | TREF | DESCRIPTION                       | SIZE   | WEIGHT | SU | CTN QTY | RRP   |
|----------|------|-----------------------------------|--------|--------|----|---------|-------|
| 22200013 | T147 | TARGETZ BULLET FEEDER S20 (10PCS) | SMALL  | 10G    | 10 | 200     | €2.65 |
| 22200014 | T147 | TARGETZ BULLET FEEDER S30 (10PCS) | SMALL  | 30G    | 10 | 200     | €2.65 |
| 22200015 | T147 | TARGETZ BULLET FEEDER S40 (10PCS) | SMALL  | 40G    | 10 | 200     | €2.65 |
| 22200016 | T147 | TARGETZ BULLET FEEDER S50 (10PCS) | SMALL  | 50G    | 10 | 200     | €2.65 |
| 22200017 | T147 | TARGETZ BULLET FEEDER M20 (10PCS) | MEDIUM | 20G    | 10 | 200     | €2.65 |
| 22200018 | T147 | TARGETZ BULLET FEEDER M30 (10PCS) | MEDIUM | 30G    | 10 | 200     | €2.65 |
| 22200019 | T147 | TARGETZ BULLET FEEDER M40 (10PCS) | MEDIUM | 40G    | 10 | 200     | €2.65 |
| 22200020 | T147 | TARGETZ BULLET FEEDER M50 (10PCS) | MEDIUM | 50G    | 10 | 200     | €2.65 |
| 22200021 | T147 | TARGETZ BULLET FEEDER M60 (10PCS) | MEDIUM | 60G    | 10 | 200     | €2.65 |
| 22200022 | T147 | TARGETZ BULLET FEEDER L20 (10PCS) | LARGE  | 20G    | 10 | 200     | €2.65 |
| 22200023 | T147 | TARGETZ BULLET FEEDER L30 (10PCS) | LARGE  | 30G    | 10 | 200     | €2.65 |
| 22200024 | T147 | TARGETZ BULLET FEEDER L40 (10PCS) | LARGE  | 40G    | 10 | 200     | €2.65 |
| 22200025 | T147 | TARGETZ BULLET FEEDER L50 (10PCS) | LARGE  | 50G    | 10 | 200     | €2.65 |
| 22200026 | T147 | TARGETZ BULLET FEEDER L60 (10PCS) | LARGE  | 60G    | 10 | 200     | €2.65 |

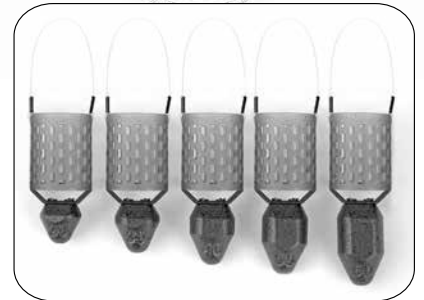



# TARGETZ



ACCESSORIES

NYTRO

## TARGETZ OPEN-END CAGE FEEDERS

The lead free Targetz Open-end Feeders are not just another open-end feeder! They are different and are available in three sizes, small, medium and large and come in a variety of popular casting weights. Designed with a contoured side, Targetz Feeders cast further, fly straight and offer less resistance in water on retrieve. The precision designed holes allow for a better water flow, making them ideal for delivering and releasing a variety of different bait. These feeders lay flat on the bottom, offering superior bait presentation. The debossed weights offer added contact with the bottom which is perfect when fishing over features.

- > Three sizes S – M – L, in various weights
- > Designed in close cooperation with Tommy Pickering
- > High-grade plastic basket rises up faster on the retrieve than wire cage feeders, avoiding obstacles on the bottom
- > Custom designed for precise long-distance casting
- > Precision engineered rounded holes ensure enhanced bait release and improved water flow
- > Weight-forward placement of weight on the side of the feeder avoids unbalance and enables added accuracy and casting distance
- > The contoured weight allows the feeder to lay straight every time it touches the bottom
- > Debossed weight and logo on the weight for added contact with the bottom, perfect when moving the feeder
- > Maximum water flow to minimize resistance in the water on the retrieve
- > Supreme bait presentation
- > Ideal for a wide variety of different bait
- > Lead free



| CODE     | TREF | DESCRIPTION                              | SIZE   | WEIGHT | SU | CTN QTY | RRP   |
|----------|------|--|--------|--------|----|---------|-------|
| 22200001 | T142 | TARGETZ OPEN-END CAGE FEEDER S10 (10PCS) | SMALL  | 10G    | 10 | 200     | €2.55 |
| 22200002 | T142 | TARGETZ OPEN-END CAGE FEEDER S15 (10PCS) | SMALL  | 15G    | 10 | 200     | €2.55 |
| 22200003 | T142 | TARGETZ OPEN-END CAGE FEEDER S20 (10PCS) | SMALL  | 20G    | 10 | 200     | €2.55 |
| 22200004 | T142 | TARGETZ OPEN-END CAGE FEEDER S25 (10PCS) | SMALL  | 25G    | 10 | 200     | €2.55 |
| 22200005 | T142 | TARGETZ OPEN-END CAGE FEEDER M20 (10PCS) | MEDIUM | 20G    | 10 | 200     | €2.55 |
| 22200006 | T142 | TARGETZ OPEN-END CAGE FEEDER M30 (10PCS) | MEDIUM | 30G    | 10 | 200     | €2.55 |
| 22200007 | T142 | TARGETZ OPEN-END CAGE FEEDER M40 (10PCS) | MEDIUM | 40G    | 10 | 200     | €2.55 |
| 22200008 | T142 | TARGETZ OPEN-END CAGE FEEDER M50 (10PCS) | MEDIUM | 50G    | 10 | 200     | €2.55 |
| 22200009 | T142 | TARGETZ OPEN-END CAGE FEEDER L20 (10PCS) | LARGE  | 20G    | 10 | 200     | €2.55 |
| 22200010 | T142 | TARGETZ OPEN-END CAGE FEEDER L30 (10PCS) | LARGE  | 30G    | 10 | 200     | €2.55 |
| 22200011 | T142 | TARGETZ OPEN-END CAGE FEEDER L40 (10PCS) | LARGE  | 40G    | 10 | 200     | €2.55 |
| 22200012 | T142 | TARGETZ OPEN-END CAGE FEEDER L50 (10PCS) | LARGE  | 50G    | 10 | 200     | €2.55 |



# TARGETZ

- > Three sizes S – M – L, in various weights
- > 6x6mm square wire frame
- > Custom designed for precise long-distance casting
- > Aerodynamic placement of the weight for added distance casting
- > Maximum water flow to minimize resistance in the water on the retrieve
- > Supreme bait presentation
- > Ideal for a wide variety of different bait offerings
- > Lead free

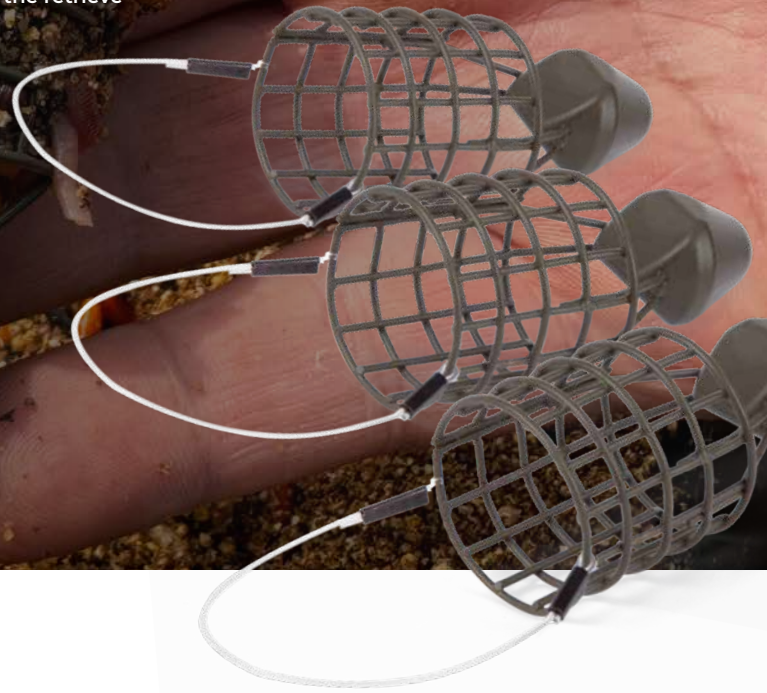

## TARGETZ 6MM WIRE BULLET FEEDER

The TARGETZ range of feeders has been expanded with a series of leadfree Wire Cage Bullet Feeders. They are available in three sizes, small – medium and large and come in a variety of popular casting weights. As a result of the specific placement of the bullet weight, Targetz Bullet Feeders cast further, fly straighter and cause less resistance on the retrieve.



| CODE     | TREF | DESCRIPTION                 | SIZE   | WEIGHT | SU | CTN QTY | RRP   |
|----------|------|-----------------------------|--------|--------|----|---------|-------|
| 22200115 | T147 | TARGETZ 6MM WIRE BULLET S20 | SMALL  | 20G    | 10 | 200     | €2.65 |
| 22200116 | T147 | TARGETZ 6MM WIRE BULLET S30 | SMALL  | 30G    | 10 | 200     | €2.65 |
| 22200117 | T147 | TARGETZ 6MM WIRE BULLET S40 | SMALL  | 40G    | 10 | 200     | €2.65 |
| 22200118 | T147 | TARGETZ 6MM WIRE BULLET S50 | SMALL  | 50G    | 10 | 200     | €2.65 |
| 22200120 | T147 | TARGETZ 6MM WIRE BULLET M20 | MEDIUM | 20G    | 10 | 200     | €2.65 |
| 22200121 | T147 | TARGETZ 6MM WIRE BULLET M30 | MEDIUM | 30G    | 10 | 200     | €2.65 |
| 22200122 | T147 | TARGETZ 6MM WIRE BULLET M40 | MEDIUM | 40G    | 10 | 200     | €2.65 |
| 22200123 | T147 | TARGETZ 6MM WIRE BULLET M50 | MEDIUM | 50G    | 10 | 200     | €2.65 |
| 22200124 | T147 | TARGETZ 6MM WIRE BULLET M60 | MEDIUM | 60G    | 10 | 200     | €2.65 |
| 22200128 | T147 | TARGETZ 6MM WIRE BULLET L30 | LARGE  | 30G    | 10 | 200     | €2.65 |
| 22200129 | T147 | TARGETZ 6MM WIRE BULLET L40 | LARGE  | 40G    | 10 | 200     | €2.65 |
| 22200130 | T147 | TARGETZ 6MM WIRE BULLET L50 | LARGE  | 50G    | 10 | 200     | €2.65 |
| 22200131 | T147 | TARGETZ 6MM WIRE BULLET L60 | LARGE  | 60G    | 10 | 200     | €2.65 |

## TARGETZ 7.5MM WIRE BULLET FEEDER

In addition to the regular 6mm Wire Cage Bullet Feeders, we have also added a medium size feeder with a 7.5 x 7.5mm square wire frame. Ideal for baiting up or when quick release of bait is required. Targetz Bullet Feeders cast further, fly straighter and cause less resistance on the retrieve.

- > Size M, in various weights
- > 7.5mm x 7.5mm square wire frame
- > Ideal for baiting up or when quick release of bait is required
- > Custom designed for precise long-distance casting
- > Aerodynamic placement of the weight for added distance casting
- > Maximum water flow to minimize resistance in the water on the retrieve
- > Supreme bait release and presentation
- > Ideal for a wide variety of different bait offerings
- > Lead free



| CODE     | TREF | DESCRIPTION                   | SIZE   | WEIGHT | SU | CTN QTY | RRP   |
|----------|------|-------------------------------|--------|--------|----|---------|-------|
| 22200125 | T147 | TARGETZ 7.5MM WIRE BULLET M30 | MEDIUM | 30G    | 10 | 200     | €2.65 |
| 22200126 | T147 | TARGETZ 7.5MM WIRE BULLET M40 | MEDIUM | 40G    | 10 | 200     | €2.65 |
| 22200127 | T147 | TARGETZ 7.5MM WIRE BULLET M50 | MEDIUM | 50G    | 10 | 200     | €2.65 |

## TARGETZ 6MM BAIT-UP FEEDER

The Targetz Bait-up Feeder M18 is specifically designed for situations when there is a need to apply larger amounts of bait or feed. The Bait-up Feeder features a mesh top and a looped and crimped twisted double mono, for extra strength when casting longer distances. Ideal for feeding ground bait or loose feed like corn, hemp, pellets, chopped worm and maggots, topped off with a layer of groundbait.

- > Size medium 18gr
- > 6 x 6mm wire frame
- > Ideal for baiting up larger volumes of bait and loose feed
- > Looped and crimped
- > Lead free

Ideal in combination with the Bait Up rod and reel (see pages 15 and 40).

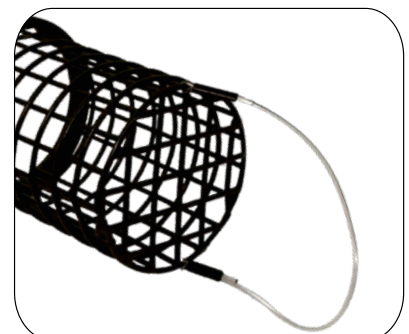

| CODE     | TREF | DESCRIPTION                    | SIZE   | WEIGHT | SU | CTN QTY | RRP   |
|----------|------|--------------------------------|--------|--------|----|---------|-------|
| 22200135 | T194 | TARGETZ 6MM BAIT-UP FEEDER M18 | MEDIUM | 18G    | 10 | 200     | €3.50 |



# TARGETZ

## TARGETZ 6MM WIRE CAGE FEEDER

The TARGETZ range of feeders has been expanded with a series of lead-free Open-end wire cage feeders. They come in three different sizes, small – medium – large and in a variety of popular casting weights. Designed with a contoured side, Targetz Wire Cage feeders cast further, fly straight and offer less resistance in water on the retrieve. These feeders lay flat on the bottom, offering superior bait presentation. The debossed weights offer added contact with the bottom which is perfect when fishing over features.

- > Three sizes S-M-L in various weights
- > 6 x 6mm square wire frame
- > Custom designed for precise long-distance casting
- > Weight-forward placement of weight on the side of the feeder, avoids unbalance and enables added accuracy and distance casting
- > The contoured weight allows the feeder to lay straight every time it touches the bottom
- > Debossed weight and logo on the weight for added contact with the bottom, perfect when moving the feeder
- > Maximum water flow to minimize resistance in the water on the retrieve
- > Supreme bait presentation
- > Ideal for a wide variety of different bait offerings
- > Lead free



| CODE     | TREF | DESCRIPTION                      | SIZE   | WEIGHT | SU | CTN QTY | RRP   |
|----------|------|----------------------------------|--------|--------|----|---------|-------|
| 22200100 | T136 | TARGETZ 6MM WIRE CAGE FEEDER S15 | SMALL  | 15G    | 10 | 200     | €2.45 |
| 22200101 | T136 | TARGETZ 6MM WIRE CAGE FEEDER S20 | SMALL  | 20G    | 10 | 200     | €2.45 |
| 22200102 | T136 | TARGETZ 6MM WIRE CAGE FEEDER S30 | SMALL  | 30G    | 10 | 200     | €2.45 |
| 22200103 | T136 | TARGETZ 6MM WIRE CAGE FEEDER S40 | SMALL  | 40G    | 10 | 200     | €2.45 |
| 22200105 | T136 | TARGETZ 6MM WIRE CAGE FEEDER M20 | MEDIUM | 20G    | 10 | 200     | €2.45 |
| 22200106 | T136 | TARGETZ 6MM WIRE CAGE FEEDER M30 | MEDIUM | 30G    | 10 | 200     | €2.45 |
| 22200107 | T136 | TARGETZ 6MM WIRE CAGE FEEDER M40 | MEDIUM | 40G    | 10 | 200     | €2.45 |
| 22200108 | T136 | TARGETZ 6MM WIRE CAGE FEEDER M50 | MEDIUM | 50G    | 10 | 200     | €2.45 |
| 22200110 | T136 | TARGETZ 6MM WIRE CAGE FEEDER L20 | LARGE  | 20G    | 10 | 200     | €2.45 |
| 22200111 | T136 | TARGETZ 6MM WIRE CAGE FEEDER L30 | LARGE  | 30G    | 10 | 200     | €2.45 |
| 22200112 | T136 | TARGETZ 6MM WIRE CAGE FEEDER L40 | LARGE  | 40G    | 10 | 200     | €2.45 |
| 22200113 | T136 | TARGETZ 6MM WIRE CAGE FEEDER L50 | LARGE  | 50G    | 10 | 200     | €2.45 |



## TARGETZ TCS INLINE FLAT METHOD FEEDERS NEW

Flat Method feeders are more popular than ever and are a very efficient way of targeting species such as carp, bream and tench. These feeders are designed to present bait in a way that attracts fish to a concentrated area, making them highly effective.

We are excited to present our new range of Leadfree Targetz TCS Inline Flat Method Feeders, crafted with innovation and environmental responsibility in mind. Here are the key features that set our feeders apart:

- > Flat profile: Lightweight, moulded hydrocarbon-polymer body combined with leadfree balanced weighted base
- > Bait retention: Equipped with a raised back end and a recessed platform that holds groundbait or pellets securely
- > Weight-distribution: Even weight-distributed on the bottom of the feeder allows for long and accurate casting
- > Efficient bait release: Our Method feeders are designed to release bait efficiently, ensuring that a small amount of bait is consistently available around the hook
- > Interchangeable system: Our TCS Inline Method Feeders feature an interchangeable system with a variety of different stem kits
- > Ease of use: The straightforward design allows for quick and easy bait loading and rigging. See our three sizes of Method Molds
- > Versatility: Our Leadfree TCS Inline Flat Method Feeders come in various sizes and weights
- > Eco-friendly design: Made from lead-free materials, these feeders are environmentally responsible, reducing the ecological impact on water bodies and ensuring a safer habitat for aquatic life

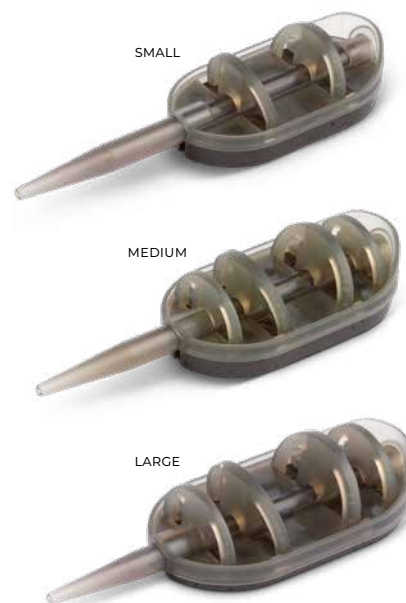

Overall, our new Leadfree TCS Inline Flat Method Feeders are a versatile and effective feeder for modern feeder fishing. Providing a reliable method for presenting bait and attracting fish to the hook. Embrace the future of fishing with our eco-friendly and highly efficient feeders, designed for best performance and environmental sustainability.

| CODE     | TREF | DESCRIPTION                       | SIZE   | SU | CTN QTY | RRP   |
|----------|------|-----------------------------------|--------|----|---------|-------|
| 22210001 | T194 | TCS INLINE FLAT METHOD FEEDER S10 | SMALL  | 5  | 200     | €3.49 |
| 22210002 | T194 | TCS INLINE FLAT METHOD FEEDER S20 | SMALL  | 5  | 200     | €3.49 |
| 22210003 | T194 | TCS INLINE FLAT METHOD FEEDER S30 | SMALL  | 5  | 200     | €3.49 |
| 22210004 | T194 | TCS INLINE FLAT METHOD FEEDER M15 | MEDIUM | 5  | 200     | €3.49 |
| 22210005 | T194 | TCS INLINE FLAT METHOD FEEDER M25 | MEDIUM | 5  | 200     | €3.49 |
| 22210006 | T194 | TCS INLINE FLAT METHOD FEEDER M35 | MEDIUM | 5  | 200     | €3.49 |
| 22210007 | T194 | TCS INLINE FLAT METHOD FEEDER M45 | MEDIUM | 5  | 200     | €3.49 |
| 22210008 | T194 | TCS INLINE FLAT METHOD FEEDER L20 | LARGE  | 5  | 200     | €3.49 |
| 22210009 | T194 | TCS INLINE FLAT METHOD FEEDER L30 | LARGE  | 5  | 200     | €3.49 |
| 22210010 | T194 | TCS INLINE FLAT METHOD FEEDER L40 | LARGE  | 5  | 200     | €3.49 |
| 22210011 | T194 | TCS INLINE FLAT METHOD FEEDER L50 | LARGE  | 5  | 200     | €3.49 |
| 22210012 | T194 | TCS INLINE FLAT METHOD FEEDER L60 | LARGE  | 5  | 200     | €3.49 |



# TCS STEMKIT



We have developed three distinct stem kits to complement the TCS Inline Method Feeders: two inline versions in varied lengths and one elasticated stem kit. The inline stem kits are ingeniously designed so that a rubber hood is not needed, as it is already incorporated into the stem design. This innovation makes them slicker and more streamlined, enhancing their performance and ease of use.



| CODE     | TREF | DESCRIPTION               | SU | CTN QTY | RRP   |
|----------|------|---------------------------|----|---------|-------|
| 22210101 | T111 | TCS STEMKIT STANDARD      | 5  | 500     | €1.99 |
| 22210102 | T203 | TCS STEMKIT ELASTICATED   | 5  | 500     | €3.65 |
| 22210103 | T139 | TCS STEMKIT LONG DISTANCE | 5  | 500     | €2.50 |

# TARGETZ FLAT METHOD LATEX MOLD



Discover our innovative Method feeder moulds, available in three sizes—small, medium, and large. Offering significant advantages over conventional latex moulds. The symmetric design ensures you never have to worry about the front or back of the feeder, while the slightly deeper mould makes adding a double layer to your method feeder easier than ever. With convenient side wings for easy opening, your moulded feeder comes out perfectly every time. Made from high-quality latex with a special coating, these moulds guarantee that the bait always releases effortlessly.



| CODE     | TREF | DESCRIPTION                  | SU | CTN QTY | RRP   |
|----------|------|------------------------------|----|---------|-------|
| 22210110 | T219 | LATEX TCS METHOD MOLD SMALL  | 5  | 200     | €3.95 |
| 22210111 | T219 | LATEX TCS METHOD MOLD MEDIUM | 5  | 200     | €3.95 |
| 22210112 | T219 | LATEX TCS METHOD MOLD LARGE  | 5  | 200     | €3.95 |





# GETTING TO THE POINT

**NYTRO**

**NYTRO**

**NYTRO**



## LIGHT MARL GREY POLO SHIRT



A stylish light marl grey, comfort fit, polo shirt with an embroidered Nytro logo on the front and w red trims on the neck and on the short sleeves. These lightweight, 200gsm polos are 100% cotton and can be worn on the bank or for general leisure wear. Available in five sizes, medium through 3XL.

- > 100% Cotton
- > Lightweight, 200gsm
- > Stylish, comfort fit model
- > Light marl grey fabric with red accents and logos
- > Machine washable
- > Available in sizes M through 3XL



| CODE     | TREF  | DESCRIPTION                    | SU | CTN QTY | RRP    |
|----------|-------|--------------------------------|----|---------|--------|
| 22500040 | T1942 | LIGHT MARL GREY POLO SHIRT M   | 1  | 40      | €34.95 |
| 22500041 | T1942 | LIGHT MARL GREY POLO SHIRT L   | 1  | 40      | €34.95 |
| 22500042 | T1942 | LIGHT MARL GREY POLO SHIRT XL  | 1  | 40      | €34.95 |
| 22500043 | T1942 | LIGHT MARL GREY POLO SHIRT 2XL | 1  | 40      | €34.95 |
| 22500044 | T1942 | LIGHT MARL GREY POLO SHIRT 3XL | 1  | 40      | €34.95 |

## LIGHT MARL GREY TEE SHIRT



Introducing a stylish light marl grey Tee-shirt with a comfortable fit, displaying a larger printed Nytro logo on the front. These lightweight Tee-shirts, weighing 180gsm, are 100% cotton, ensuring comfort whether on the bank or for casual wear. Available in five sizes, from medium to 3XL.

- > 100% Cotton
- > Lightweight, 180gsm
- > Stylish, comfort fit model
- > Light marl grey fabric with red accents and logos
- > Machine washable
- > Available in sizes M through 3XL



| CODE     | TREF  | DESCRIPTION                   | SU | CTN QTY | RRP    |
|----------|-------|-------------------------------|----|---------|--------|
| 22500045 | T1386 | LIGHT MARL GREY TEE SHIRT M   | 1  | 50      | €24.95 |
| 22500046 | T1386 | LIGHT MARL GREY TEE SHIRT L   | 1  | 50      | €24.95 |
| 22500047 | T1386 | LIGHT MARL GREY TEE SHIRT XL  | 1  | 50      | €24.95 |
| 22500048 | T1386 | LIGHT MARL GREY TEE SHIRT 2XL | 1  | 50      | €24.95 |
| 22500049 | T1386 | LIGHT MARL GREY TEE SHIRT 3XL | 1  | 50      | €24.95 |



## UVP50 LONG SLEEVE SHIRT



Ideal for fishing in warm weather conditions, this UVP50 long sleeve performance shirt offers flexibility, comfort, and breathability. Providing full body cover, it ensures maximum protection for the arms.

- > Long sleeve design for comprehensive arm coverage
- > UVP50 rating blocks at least 98% of harmful UV rays
- > Features a bold Nytro design
- > Crafted from high-quality 160gsm Silk Lycra
- > Made of 100% polyester for durability
- > Quick-drying fabric for added convenience
- > Machine washable for easy care
- > Available in sizes M through 3XL

| CODE     | TREF  | DESCRIPTION                     | SU | CTN QTY | RRP    |
|----------|-------|---------------------------------|----|---------|--------|
| 22500050 | T2219 | NYTRO TEE SHIRT LONG SLEEVE UVP | 1  | 50      | €39.95 |
| 22500051 | T2219 | NYTRO TEE SHIRT LONG SLEEVE UVP | 1  | 50      | €39.95 |
| 22500052 | T2219 | NYTRO TEE SHIRT LONG SLEEVE UVP | 1  | 50      | €39.95 |
| 22500053 | T2219 | NYTRO TEE SHIRT LONG SLEEVE UVP | 1  | 50      | €39.95 |
| 22500054 | T2219 | NYTRO TEE SHIRT LONG SLEEVE UVP | 1  | 50      | €39.95 |



## HOODY DARK MARL GREY



These Nytro hoodies are described as stylish, featuring a dark marl grey colour and are highly practical. Crafted from 300gsm fabric, they are made of 60% cotton and 40% polyester, ensuring both warmth and comfort. Added features include elasticated cuffs and a drawcord hood, plus an easy-access hand-warmer style front pocket. Available in sizes ranging from medium to 3XL.

- > 60% Cotton, 40% Polyester 300gsm
- > Comfort fit with draw string hood
- > Stylish dark marl grey with red accents inside the hood
- > Prominent display of logos on front, back and sides
- > Available in sizes M through 3XL

| CODE     | TREF  | DESCRIPTION                   | SU | CTN QTY | RRP    |
|----------|-------|-------------------------------|----|---------|--------|
| 22500055 | T2275 | HOODY DARK MARL GREY MEDIUM   | 1  | 20      | €49.95 |
| 22500056 | T2275 | HOODY DARK MARL GREY LARGE    | 1  | 20      | €49.95 |
| 22500057 | T2275 | HOODY DARK MARL GREY X-LARGE  | 1  | 20      | €49.95 |
| 22500058 | T2275 | HOODY DARK MARL GREY 2X-LARGE | 1  | 20      | €49.95 |
| 22500059 | T2275 | HOODY DARK MARL GREY 3X-LARGE | 1  | 20      | €49.95 |



## ZIPPED HOODY TRI-COLOR



The Nytro zipped Tri-Colour hoodies are stylish, comfortable, and highly practical. Crafted from 320gsm fabric, they consist of 60% cotton and 40% polyester, ensuring warmth and comfort. Added features include a full front zipper, elasticated cuffs, a drawcord hood, and side pockets with zippers. Available in five sizes, from medium to 3XL.

- > 60% Cotton, 40% Polyester 320gsm
- > Comfort fit with draw string hood
- > Modern tri-colour design in red, black and dark marl grey
- > Prominent display of logos on front and sides
- > Available in sizes M through 3XL

| CODE     | TREF  | DESCRIPTION                     | SU | CTN QTY | RRP    |
|----------|-------|---------------------------------|----|---------|--------|
| 22500060 | T3331 | ZIPPED HOODY TRI-COLOR MEDIUM   | 1  | 20      | €59.95 |
| 22500061 | T3331 | ZIPPED HOODY TRI-COLOR LARGE    | 1  | 20      | €59.95 |
| 22500062 | T3331 | ZIPPED HOODY TRI-COLOR X-LARGE  | 1  | 20      | €59.95 |
| 22500063 | T3331 | ZIPPED HOODY TRI-COLOR 2X-LARGE | 1  | 20      | €59.95 |
| 22500064 | T3331 | ZIPPED HOODY TRI-COLOR 3X-LARGE | 1  | 20      | €59.95 |





# JOGGERS DARK MARL GREY



Stylish, comfort-fit and designed using 300gsm fabric comprising 60% cotton and 40% polyester, ensuring warmth and comfort. These dark marl grey Nytro joggers have added features including elasticated waistband with red drawcord, leg logo and zip side pockets. Available in five sizes, medium through 3XL.

- > 60% Cotton, 40% Polyester
- > Lightweight, 300gsm
- > Comfort fit
- > Side pockets
- > Elasticated waist band with red draw string
- > Printed Nytro logo on one leg
- > Available in sizes M through 3XL

| CODE     | TREF  | DESCRIPTION                     | SU | CTN QTY | RRP    |
|----------|-------|---------------------------------|----|---------|--------|
| 22500065 | T2219 | JOGGERS DARK MARL GREY MEDIUM   | 1  | 30      | €39.95 |
| 22500066 | T2219 | JOGGERS DARK MARL GREY LARGE    | 1  | 30      | €39.95 |
| 22500067 | T2219 | JOGGERS DARK MARL GREY X-LARGE  | 1  | 25      | €39.95 |
| 22500068 | T2219 | JOGGERS DARK MARL GREY 2X-LARGE | 1  | 25      | €39.95 |
| 22500069 | T2219 | JOGGERS DARK MARL GREY 3X-LARGE | 1  | 25      | €39.95 |



# JOGGER SHORTS



Stylish, comfort-fit and designed using 240gsm fabric comprising 70% cotton and 30% polyester, ensuring warmth and comfort. The dark marl grey Nytro jogger shorts have added features including elasticated waistband with red drawcord, leg logo and zip side pockets. Available in five sizes, medium through 3XL.

- > 80% Cotton, 20% Polyester
- > Lightweight, 290gsm
- > Comfort fit shorts
- > Side pockets
- > Elasticated waist band with red draw string
- > High-quality logo embroideries on front
- > Available in sizes M through 3XL

| CODE     | TREF  | DESCRIPTION                      | SU | CTN QTY | RRP    |
|----------|-------|----------------------------------|----|---------|--------|
| 22500070 | T1664 | JOGGER SHORTS MARL GREY MEDIUM   | 1  | 40      | €29.95 |
| 22500071 | T1664 | JOGGER SHORTS MARL GREY LARGE    | 1  | 40      | €29.95 |
| 22500072 | T1664 | JOGGER SHORTS MARL GREY X-LARGE  | 1  | 40      | €29.95 |
| 22500073 | T1664 | JOGGER SHORTS MARL GREY 2X-LARGE | 1  | 40      | €29.95 |
| 22500074 | T1664 | JOGGER SHORTS MARL GREY 3X-LARGE | 1  | 40      | €29.95 |



# BLACK & MARL GRAY CLASSIC NYTRO CAP



High quality, cotton twill baseball cap with a five-row stitching red visor and embroidered Nytro logo on the front.

- > High quality, six-panel baseball cap with embroidered logo detail
- > Cotton twill
- > Five-row stitching on visor
- > Classic fit
- > One size fit all

| CODE     | TREF | DESCRIPTION                         | SU | CTN QTY | RRP    |
|----------|------|-------------------------------------|----|---------|--------|
| 22500075 | T831 | BLACK & MARL GRAY CLASSIC NYTRO CAP | 1  | 100     | €14.95 |



## LIGHT MARL GREY TRUCKER NYTRO CAP



This high-quality trucker cap, with mesh on the back and embroidered logo on the front does not just look cool, it keeps your head cool in summer too. Fully adjustable so one size fits all.

- > High quality, five-panel trucker cap with embroidered logo detail
- > Mesh back
- > Cotton twill
- > Five-row stitching on visor
- > Classic fit
- > One size fit all

| CODE     | TREF | DESCRIPTION                       | SU | CTN QTY | RRP    |
|----------|------|-----------------------------------|----|---------|--------|
| 22500076 | T831 | LIGHT MARL GREY TRUCKER NYTRO CAP | 1  | 100     | €14.95 |



## NYTRO FISHING CAP

High quality, cotton twill baseball cap with a five-row stitching visor and embroidered Nytro logo on the front.

- > High quality, six-panel baseball cap with embroidered logo detail
- > Cotton twill
- > FiverRow stitching on visor
- > Classic fit
- > One size fits all

| CODE     | TREF | DESCRIPTION       | SU | CTN QTY | RRP    |
|----------|------|-------------------|----|---------|--------|
| 22500031 | T831 | NYTRO FISHING CAP | 1  | 100     | €14.95 |



## NYTRO FISHING CAP (MESH BACK)

This high quality trucker cap, with mesh on the back and an embroidered logo on the front does not just look cool, it keeps your head cool in summer too. Fully adjustable so one size fits all.

- > High quality, five-panel trucker cap with embroidered logo detail
- > Mesh back
- > Cotton twill
- > Five-row stitching on visor
- > Classic fit
- > One size fits all

| CODE     | TREF | DESCRIPTION                   | SU | CTN QTY | RRP    |
|----------|------|-------------------------------|----|---------|--------|
| 22500031 | T831 | NYTRO FISHING CAP (MESH BACK) | 1  | 100     | €14.95 |



CLOTHING

NYTRO



CLOTHING

NYTRO



## 3/4 JACKET +BIB'N'BRACE WP

NEW

The Nytro Fishing Suit is designed for ultimate comfort and protection in all weather conditions. The jacket is an ideal length for easy movement while seated. Featuring a high neck for maximum protection against the elements and waterproof zips on both pockets on the chest and the main central zip. Neoprene cuffs with thumb holes guard against draughts while the waterproof hood and adjustable toggle cord ensures complete weatherproofing. With three fully waterproof pockets, you'll have ample storage for all your essentials, plus one more internal pocket. The bib & brace is equipped with three fully waterproof zips with storm flaps and pullers, wide opening adjustable ankle areas and adjustable shoulder and chest straps for a perfect fit. Stay dry, comfortable and ready for action with the Nytro Fishing Suit.

### Jacket

- > Ideal length
- > High neck for maximum protection
- > Waterproof zips
- > Neoprene cuffs with thumb holes
- > Waterproof hood and adjustable toggle cord
- > Fully waterproof pockets plus internal pocket



### Bib & Brace

- > Fully waterproof zips with storm flaps and pullers
- > Flared adjustable ankle areas
- > Adjustable back and chest shoulder straps



| CODE     | TREF   | DESCRIPTION                          | SU | CTN QTY | RRP     |
|----------|--------|--------------------------------------|----|---------|---------|
| 22510001 | T11108 | 3/4 JACKET + BIB'N'BRACE WP MEDIUM   | 1  | 10      | €199.95 |
| 22510002 | T11108 | 3/4 JACKET + BIB'N'BRACE WP LARGE    | 1  | 10      | €199.95 |
| 22510003 | T11108 | 3/4 JACKET + BIB'N'BRACE WP X-LARGE  | 1  | 10      | €199.95 |
| 22510004 | T11108 | 3/4 JACKET + BIB'N'BRACE WP 2X-LARGE | 1  | 10      | €199.95 |
| 22510005 | T11108 | 3/4 JACKET + BIB'N'BRACE WP 3X-LARGE | 1  | 10      | €199.95 |



POS

NYTRO  
performance first

## NYTRO WALL DISPLAY



Enhance your retail display area with a bespoke wall display unit which are now available in one-meter sections! Finished in black and complete with a logo light box and shelving, the panelling enables the use of display hooks to hang various items of merchandise.

Each shelf comes with a slide in POS brand strip to identify the brand. Easy to put together and separate one-meter add-ons can be added to increase the display width.

Available to order on our B2B or talk with your sales manager who will be happy to advise on cost and fitting.

- > 100CM (1M) wide racking
- > Base-shelf is 47CM
- > Mid-shelf (x2) is 37CM
- > Solid 40CM back panel
- > Six 30CM perforated back panels
- > Canopy includes internal light unit

| CODE   | TREF   | DESCRIPTION                         | SU |
|--------|--------|-------------------------------------|----|
| MA0032 | T42995 | NYTRO WALL DISPLAY START MODULE     | 1  |
| MA0033 | T40600 | NYTRO WALL DISPLAY ADD-ON MODULE    | 1  |
| MA0042 | T130   | GENERIC DOUBLE BLACK PEG L20CM (50) | 50 |



## NYTRO ROD RACK



Display your rods with one of our bespoke branded rod racks, which are now available to order through our B2B or your sales manager.

Each stand comes flat-packed and is quick and easy to assemble. Each stand can display 10 fully made-up rods on each side, allowing storage and display for 20 rods.

Made from hard wood and featuring brand awareness graphic. The ideal solution for rod display in retail space or outdoor events.

- > Displays 20 rods - 10 rods per side
- > Height 100cm
- > Width 40cm
- > Length 60cm

| CODE     | TREF  | DESCRIPTION              | SU |
|----------|-------|--------------------------|----|
| 28100000 | T9995 | NYTRO ROD RACK (20 RODS) | 1  |





SPARES



NYTRO  
SPECIALTY EQUIPMENT**NTR COMMERCIAL RANGE ROD SPARES**

| CODE      | TREF  | DESCRIPTION                  | RRP    |
|-----------|-------|------------------------------|--------|
| Z2020003C | T497  | NTR 9' CARP FEEDER CARRIER   | €8.95  |
| Z2020003B | T831  | NTR 9' CARP FEEDER BUTT      | €14.95 |
| Z2020004C | T553  | NTR 10' CARP FEEDER CARRIER  | €9.95  |
| Z2020004B | T997  | NTR 10' CARP FEEDER BUTT     | €17.95 |
| Z2020005C | T608  | NTR 11' CARP FEEDER CARRIER  | €10.95 |
| Z2020005B | T1164 | NTR 11' CARP FEEDER BUTT     | €20.95 |
| Z2020006T | T997  | NTR 10' PELLETT WAGGLER TIP  | €17.95 |
| Z2020006B | T1553 | NTR 10' PELLETT WAGGLER BUTT | €27.95 |
| Z2020007T | T1053 | NTR 11' PELLETT WAGGLER TIP  | €18.95 |
| Z2020007B | T1664 | NTR 11' PELLETT WAGGLER BUTT | €29.95 |

**IMPAX COMMERCIAL RANGE ROD SPARES**

| CODE      | TREF  | DESCRIPTION                    | RRP    |
|-----------|-------|--------------------------------|--------|
| Z2020010C | T831  | IMPAX 9' CARP FEEDER CARRIER   | €14.95 |
| Z2020010B | T1108 | IMPAX 9' CARP FEEDER BUTT      | €19.95 |
| Z2020011C | T719  | IMPAX 10' CARP FEEDER CARRIER  | €12.95 |
| Z2020011B | T1331 | IMPAX 10' CARP FEEDER BUTT     | €23.95 |
| Z2020012C | T831  | IMPAX 11' CARP FEEDER CARRIER  | €14.95 |
| Z2020012B | T1497 | IMPAX 11' CARP FEEDER BUTT     | €26.95 |
| Z2020008T | T1108 | IMPAX 10' PELLETT WAGGLER TIP  | €19.95 |
| Z2020008B | T1942 | IMPAX 10' PELLETT WAGGLER BUTT | €34.95 |
| Z2020009T | T1164 | IMPAX 11' PELLETT WAGGLER TIP  | €20.95 |
| Z2020009B | T2108 | IMPAX 11' PELLETT WAGGLER BUTT | €37.95 |

**IMPAX POWER METHOD ROD SPARES**

| CODE       | TREF  | DESCRIPTION  | RRP    |
|------------|-------|--|--------|
| Z20200120B | T1664 | IMPAX POWER METHOD 80 2.40 BUTT     | €29.95 |
| Z20200120C | T717  | IMPAX POWER METHOD 80 2.40 CARRIER  | €12.90 |
| Z20200121B | T1831 | IMPAX POWER METHOD 80 2.70 BUTT     | €32.95 |
| Z20200121C | T775  | IMPAX POWER METHOD 80 2.70 CARRIER  | €13.95 |

**IMPAX ALLROUNDER ROD SPARES**

| CODE       | TREF  | DESCRIPTION                  | RRP    |
|------------|-------|------------------------------|--------|
| Z20200070C | T831  | IMPAX ALLROUNDER 8' CARRIER  | €14.95 |
| Z20200070B | T1442 | IMPAX ALLROUNDER 8' BUTT     | €25.95 |
| Z20200071C | T1331 | IMPAX ALLROUNDER 9' CARRIER  | €23.95 |
| Z20200071B | T1553 | IMPAX ALLROUNDER 9' BUTT     | €27.95 |
| Z20200072C | T997  | IMPAX ALLROUNDER 10' CARRIER | €17.95 |
| Z20200072B | T1664 | IMPAX ALLROUNDER 10' BUTT    | €29.95 |
| Z20200073C | T608  | IMPAX ALLROUNDER 11' CARRIER | €10.95 |
| Z20200073M | T1164 | IMPAX ALLROUNDER 11' MIDDLE  | €20.95 |
| Z20200073B | T1497 | IMPAX ALLROUNDER 11' BUTT    | €26.95 |
| Z20200074C | T608  | IMPAX ALLROUNDER 12' CARRIER | €10.95 |
| Z20200074M | T1219 | IMPAX ALLROUNDER 12' MIDDLE  | €21.95 |
| Z20200074B | T1608 | IMPAX ALLROUNDER 12' BUTT    | €28.95 |
| Z20200075C | T664  | IMPAX ALLROUNDER 13' CARRIER | €11.95 |
| Z20200075M | T1275 | IMPAX ALLROUNDER 13' MIDDLE  | €22.95 |
| Z20200075B | T1664 | IMPAX ALLROUNDER 13' BUTT    | €29.95 |



SPARES



### IMPAX POWER FEEDER ROD SPARES

| CODE      | TREF  | DESCRIPTION                    | RRP    |
|-----------|-------|--------------------------------|--------|
| Z2020080C | T608  | IMPAX POWER FEEDER 12' CARRIER | €10.95 |
| Z2020080M | T1219 | IMPAX POWER FEEDER 12' MIDDLE  | €21.95 |
| Z2020080B | T1664 | IMPAX POWER FEEDER 12' BUTT    | €29.95 |
| Z2020081C | T664  | IMPAX POWER FEEDER 13' CARRIER | €11.95 |
| Z2020081M | T1331 | IMPAX POWER FEEDER 13' MIDDLE  | €23.95 |
| Z2020081B | T1719 | IMPAX POWER FEEDER 13' BUTT    | €30.95 |
| Z2020082C | T664  | IMPAX POWER FEEDER 12' CARRIER | €11.95 |
| Z2020082M | T1275 | IMPAX POWER FEEDER 12' MIDDLE  | €22.95 |
| Z2020082B | T1775 | IMPAX POWER FEEDER 12' BUTT    | €31.95 |
| Z2020083C | T664  | IMPAX POWER FEEDER 13' CARRIER | €11.95 |
| Z2020083M | T1331 | IMPAX POWER FEEDER 13' MIDDLE  | €23.95 |
| Z2020083B | T1775 | IMPAX POWER FEEDER 13' BUTT    | €31.95 |
| Z2020084C | T664  | IMPAX POWER FEEDER 12' CARRIER | €11.95 |
| Z2020084M | T1275 | IMPAX POWER FEEDER 12' MIDDLE  | €22.95 |
| Z2020084B | T1719 | IMPAX POWER FEEDER 12' BUTT    | €30.95 |
| Z2020085C | T664  | IMPAX POWER FEEDER 13' CARRIER | €11.95 |
| Z2020085M | T1331 | IMPAX POWER FEEDER 13' MIDDLE  | €23.95 |
| Z2020085B | T1775 | IMPAX POWER FEEDER 13' BUTT    | €31.95 |

### SOLUS COMMERCIAL RANGE ROD SPARES

| CODE      | TREF  | DESCRIPTION                     | RRP    |
|-----------|-------|---------------------------------|--------|
| Z2020015T | T1442 | SOLUS 10' PELLET WAGGLER TIP    | €25.95 |
| Z2020015B | T2719 | SOLUS 10' PELLET WAGGLER BUTT   | €48.95 |
| Z2020016T | T1664 | SOLUS 11' PELLET WAGGLER TIP    | €29.95 |
| Z2020016B | T2942 | SOLUS 11' PELLET WAGGLER BUTT   | €52.95 |
| Z2020017C | T886  | SOLUS 9' CARP FEEDER CARRIER    | €15.95 |
| Z2020017B | T2386 | SOLUS 9' CARP FEEDER BUTT       | €42.95 |
| Z2020018C | T1053 | SOLUS 10' CARP FEEDER CARRIER   | €18.95 |
| Z2020018B | T2664 | SOLUS 10' CARP FEEDER BUTT      | €47.95 |
| Z2020019C | T1164 | SOLUS 11' CARP FEEDER CARRIER   | €20.95 |
| Z2020019B | T2886 | SOLUS 11' CARP FEEDER BUTT      | €51.95 |
| Z2020020C | T1331 | SOLUS 12' METHOD FEEDER CARRIER | €23.95 |
| Z2020020B | T3275 | SOLUS 12' METHOD FEEDER BUTT    | €58.95 |

### SOLUS COMMERCIAL RANGE ROD SPARES

| CODE      | TREF  | DESCRIPTION                        | RRP    |
|-----------|-------|------------------------------------|--------|
| Z2020023C | T664  | SOLUS 10'8" ALLR FEEDER 30 CARRIER | €11.95 |
| Z2020023M | T1275 | SOLUS 10'8" ALLR FEEDER 30 MIDDLE  | €22.95 |
| Z2020023B | T2386 | SOLUS 10'8" ALLR FEEDER 30 BUTT    | €42.95 |
| Z2020024C | T664  | SOLUS 11' ALLR FEEDER 45 CARRIER   | €11.95 |
| Z2020024M | T1331 | SOLUS 11' ALLR FEEDER 45 MIDDLE    | €23.95 |
| Z2020024B | T2553 | SOLUS 11' ALLR FEEDER 45 BUTT      | €45.95 |
| Z2020025C | T886  | SOLUS 12' ALLR FEEDER 60 CARRIER   | €15.95 |
| Z2020025M | T1497 | SOLUS 12' ALLR FEEDER 60 MIDDLE    | €26.95 |
| Z2020025B | T2719 | SOLUS 12' ALLR FEEDER 60 BUTT      | €48.95 |
| Z2020026C | T886  | SOLUS 13' ALLR FEEDER 75 CARRIER   | €15.95 |
| Z2020026M | T1719 | SOLUS 13' ALLR FEEDER 75 MIDDLE    | €30.95 |
| Z2020026B | T2997 | SOLUS 13' ALLR FEEDER 75 BUTT      | €53.95 |



SPARES



### ARYZON COMMERCIAL RANGE ROD SPARES

| CODE      | TREF  | DESCRIPTION                      | RRP    |
|-----------|-------|----------------------------------|--------|
| Z2020030T | T1442 | ARYZON 10' PELLET WAGGLER TIP    | €25.95 |
| Z2020030B | T3053 | ARYZON 10' PELLET WAGGLER BUTT   | €54.95 |
| Z2020031T | T1608 | ARYZON 11' PELLET WAGGLER TIP    | €28.95 |
| Z2020031B | T3386 | ARYZON 11' PELLET WAGGLER BUTT   | €60.95 |
| Z2020032C | T886  | ARYZON 9' CARP FEEDER CARRIER    | €15.95 |
| Z2020032B | T2164 | ARYZON 9' CARP FEEDER BUTT       | €38.95 |
| Z2020033C | T1053 | ARYZON 10' CARP FEEDER CARRIER   | €18.95 |
| Z2020033B | T2386 | ARYZON 10' CARP FEEDER BUTT      | €42.95 |
| Z2020034C | T1664 | ARYZON 11' CARP FEEDER CARRIER   | €29.95 |
| Z2020034B | T3108 | ARYZON 11' CARP FEEDER BUTT      | €55.95 |
| Z2020035C | T1331 | ARYZON 12' METHOD FEEDER CARRIER | €23.95 |
| Z2020035B | T2886 | ARYZON 12' METHOD FEEDER BUTT    | €51.95 |

### ARYZON CONTINENTAL RANGE ROD SPARES

| CODE      | TREF  | DESCRIPTION                         | RRP    |
|-----------|-------|-------------------------------------|--------|
| Z2020038C | T1719 | ARYZON CONT FEEDER 330/50G CARRIER  | €30.95 |
| Z2020038B | T2553 | ARYZON CONT FEEDER 330/50G BUTT     | €45.95 |
| Z2020039C | T1775 | ARYZON CONT FEEDER 360/60G CARRIER  | €31.95 |
| Z2020039B | T2664 | ARYZON CONT FEEDER 360/60G BUTT     | €47.95 |
| Z2020040C | T997  | ARYZON CONT FEEDER 380/80G CARRIER  | €17.95 |
| Z2020040M | T1497 | ARYZON CONT FEEDER 380/80G MIDDLE   | €26.95 |
| Z2020040B | T2497 | ARYZON CONT FEEDER 380/80G BUTT     | €44.95 |
| Z2020041C | T1108 | ARYZON CONT FEEDER 400/100G CARRIER | €19.95 |
| Z2020041M | T1664 | ARYZON CONT FEEDER 400/100G MIDDLE  | €29.95 |
| Z2020041B | T2719 | ARYZON CONT FEEDER 400/100G BUTT    | €48.95 |
| Z2020042C | T1164 | ARYZON CONT FEEDER 400/130G CARRIER | €20.95 |
| Z2020042M | T1719 | ARYZON CONT FEEDER 400/130G MIDDLE  | €30.95 |
| Z2020042B | T2831 | ARYZON CONT FEEDER 400/130G BUTT    | €50.95 |
| Z2020043C | T1164 | ARYZON CONT FEEDER 400/160G CARRIER | €20.95 |
| Z2020043M | T1775 | ARYZON CONT FEEDER 60G MIDDLE       | €31.95 |
| Z2020043B | T2942 | ARYZON CONT FEEDER 60G BUTT         | €52.95 |

### ARYZON DISTANCE FEEDER ROD SPARES

| CODE      | TREF  | DESCRIPTION                         | RRP        |
|-----------|-------|-------------------------------------|------------|
| Z2020090C | T1108 | ARYZON DISTANCE FEEDER 12' CARRIER  | €19.95     |
| Z2020090M | T1386 | ARYZON DISTANCE FEEDER 12' MIDDLE   | €24.95     |
| Z2020090B | T1886 | ARYZON DISTANCE FEEDER 12' BUTT     | €33.95     |
| Z2020124C | T1108 | ARYZON DPWR FEEDER 12'6" CARRIER    | NEW €19.95 |
| Z2020124M | T1664 | ARYZON DPWR FEEDER 12'6" MIDDLE     | NEW €29.95 |
| Z2020124B | T1997 | ARYZON DPWR FEEDER 12'6" BUTT       | NEW €35.95 |
| Z2020091C | T1219 | ARYZON DISTANCE FEEDER 13' CARRIER  | €21.95     |
| Z2020091M | T1497 | ARYZON DISTANCE FEEDER 13' MIDDLE   | €26.95     |
| Z2020091B | T2164 | ARYZON DISTANCE FEEDER 13' BUTT     | €38.95     |
| Z2020092C | T1219 | ARYZON DISTANCE FEEDER 13' CARRIER  | €21.95     |
| Z2020092M | T1553 | ARYZON DISTANCE FEEDER 13' MIDDLE   | €27.95     |
| Z2020092B | T2219 | ARYZON DISTANCE FEEDER 13' BUTT     | €39.95     |
| Z2020093C | T1331 | ARYZON DISTANCE FEEDER 13' CARRIER  | €23.95     |
| Z2020093M | T1608 | ARYZON DISTANCE FEEDER 13' MIDDLE   | €28.95     |
| Z2020093B | T2386 | ARYZON DISTANCE FEEDER 13' BUTT     | €42.95     |
| Z2020125C | T1386 | ARYZON DPWR FEEDER 14' 120G CARRIER | NEW €24.95 |
| Z2020125M | T2053 | ARYZON DPWR FEEDER 14' 120G MIDDLE  | NEW €36.95 |
| Z2020125B | T2442 | ARYZON DPWR FEEDER 14' 120G BUTT    | NEW €43.95 |
| Z2020126C | T1442 | ARYZON DPWR FEEDER 14' 160G CARRIER | NEW €25.95 |
| Z2020126M | T2164 | ARYZON DPWR FEEDER 14' 160G MIDDLE  | NEW €38.95 |
| Z2020126B | T2553 | ARYZON DPWR FEEDER 14' 160G BUTT    | NEW €45.95 |

### ARYZON DISTANCE POWER BAIT-UP RANGE ROD SPARES

| CODE      | TREF  | DESCRIPTION                  | RRP        |
|-----------|-------|------------------------------|------------|
| Z2020139T | T2108 | ARYZON DPWR BAIT-UP ROD TIP  | NEW €37.95 |
| Z2020139B | T2497 | ARYZON DPWR BAIT-UP ROD BUTT | NEW €44.95 |





SPARES



### STARKX METHOD RANGE ROD SPARES

| CODE       | TREF  | DESCRIPTION                         | RRP    |
|------------|-------|-------------------------------------|--------|
| Z20200051C | T775  | STARKX 330H METHOD 90 11' CARRIER   | €13.95 |
| Z20200051M | T1219 | STARKX 330H METHOD 90 11' MIDDLE    | €21.95 |
| Z20200051B | T1608 | STARKX 330H METHOD 90 11' BUTT      | €28.95 |
| Z20200052C | T942  | STARKX 360H METHOD 100 12' CARRIER  | €16.95 |
| Z20200052M | T1386 | STARKX 360H METHOD 100 12' MIDDLE   | €24.95 |
| Z20200052B | T1664 | STARKX 360H METHOD 100 12' BUTT     | €29.95 |
| Z20200053C | T997  | STARKX 360XH METHOD 140 12' CARRIER | €17.95 |
| Z20200053M | T1497 | STARKX 360XH METHOD 140 12' MIDDLE  | €26.95 |
| Z20200053B | T1775 | STARKX 360XH METHOD 140 12' BUTT    | €31.95 |
| Z20200054C | T997  | STARKX 390H METHOD 100 13' CARRIER  | €17.95 |
| Z20200054M | T1553 | STARKX 390H METHOD 100 13' MIDDLE   | €27.95 |
| Z20200054B | T1831 | STARKX 390H METHOD 100 13' BUTT     | €32.95 |
| Z20200055C | T1053 | STARKX 390XH METHOD 150 13' CARRIER | €18.95 |
| Z20200055M | T1608 | STARKX 390XH METHOD 150 13' MIDDLE  | €28.95 |
| Z20200055B | T1886 | STARKX 390XH METHOD 150 13' BUTT    | €33.95 |
| Z20200056C | T1108 | STARKX 420XH METHOD 150 14' CARRIER | €19.95 |
| Z20200056M | T1775 | STARKX 420XH METHOD 150 14' MIDDLE  | €31.95 |
| Z20200056B | T2108 | STARKX 420XH METHOD 150 14' BUTT    | €37.95 |

### STARKX BIG RIVER RANGE ROD SPARES

| CODE       | TREF  | DESCRIPTION                         | RRP    |
|------------|-------|-------------------------------------|--------|
| Z20200057C | T1053 | STARKX B RIVER 330MH FEEDER CARRIER | €18.95 |
| Z20200057M | T1664 | STARKX B RIVER 330MH FEEDER MIDDLE  | €29.95 |
| Z20200057B | T2386 | STARKX B RIVER 330MH FEEDER BUTT    | €42.95 |
| Z20200058C | T1108 | STARKX B RIVER 330H FEEDER CARRIER  | €19.95 |
| Z20200058M | T1775 | STARKX B RIVER 330H FEEDER MIDDLE   | €31.95 |
| Z20200058B | T2664 | STARKX B RIVER 330H FEEDER BUTT     | €47.95 |
| Z20200059C | T1164 | STARKX B RIVER 360MH FEEDER CARRIER | €20.95 |
| Z20200059M | T1831 | STARKX B RIVER 360MH FEEDER MIDDLE  | €32.95 |
| Z20200059B | T2719 | STARKX B RIVER 360MH FEEDER BUTT    | €48.95 |
| Z20200060C | T1275 | STARKX B RIVER 360H FEEDER CARRIER  | €22.95 |
| Z20200060M | T1997 | STARKX B RIVER 360H FEEDER MIDDLE   | €35.95 |
| Z20200060B | T2997 | STARKX B RIVER 360H FEEDER BUTT     | €53.95 |
| Z20200061C | T1386 | STARKX B RIVER 390H FEEDER CARRIER  | €24.95 |
| Z20200061M | T2108 | STARKX B RIVER 390H FEEDER MIDDLE   | €37.95 |
| Z20200061B | T3164 | STARKX B RIVER 390H FEEDER BUTT     | €56.95 |
| Z20200062C | T1497 | STARKX B RIVER 390XH FEEDER CARRIER | €26.95 |
| Z20200062M | T2164 | STARKX B RIVER 390XH FEEDER MIDDLE  | €38.95 |
| Z20200062B | T3386 | STARKX B RIVER 390XH FEEDER BUTT    | €60.95 |
| Z20200063C | T1608 | STARKX B RIVER 420XH FEEDER CARRIER | €28.95 |
| Z20200063M | T2275 | STARKX B RIVER 420XH FEEDER MIDDLE  | €40.95 |
| Z20200063B | T3497 | STARKX B RIVER 420XH FEEDER BUTT    | €62.95 |
| Z20200064C | T1664 | STARKX B RIVER420XXH FEEDER CARRIER | €29.95 |
| Z20200064M | T2442 | STARKX B RIVER420XXH FEEDER MIDDLE  | €43.95 |
| Z20200064B | T3664 | STARKX B RIVER420XXH FEEDER BUTT    | €65.95 |

### STARKX SPECIALIST RANGE ROD SPARES

| CODE       | TREF  | DESCRIPTION                      | RRP    |
|------------|-------|----------------------------------|--------|
| Z20200129T | T1831 | STARKX SPEC. 12' 1,75-2LB TIP    | €32.95 |
| Z20200129B | T2497 | STARKX SPEC. 12' 1,75-2LB BUTT   | €44.95 |
| Z20200130T | T1942 | STARKX SPEC. 12' 2,25-2,5LB TIP  | €34.95 |
| Z20200130B | T2608 | STARKX SPEC. 12' 2,25-2,5LB BUTT | €46.95 |

### MARVELIST LIGHT CARP ROD SPARES

| CODE       | TREF  | DESCRIPTION                      | RRP    |
|------------|-------|----------------------------------|--------|
| Z20200099C | T1275 | MARVELIST LIGHT CARP 9' CARRIER  | €22.95 |
| Z20200099B | T1886 | MARVELIST LIGHT CARP 9' BUTT     | €33.95 |
| Z20200100C | T1442 | MARVELIST LIGHT CARP 10' CARRIER | €25.95 |
| Z20200100B | T1997 | MARVELIST LIGHT CARP 10' BUTT    | €35.95 |
| Z20200101C | T1719 | MARVELIST LIGHT CARP 11' CARRIER | €30.95 |
| Z20200101B | T2275 | MARVELIST LIGHT CARP 11' BUTT    | €40.95 |



SPARES

NYTRO  
SPECIALTY EQUIPMENT**MARVELIST CARP ROD SPARES**

| CODE       | TREF  | DESCRIPTION                | RRP    |
|------------|-------|----------------------------|--------|
| Z20200102C | T1442 | MARVELIST CARP 9' CARRIER  | €25.95 |
| Z20200102B | T2275 | MARVELIST CARP 9' BUTT     | €40.95 |
| Z20200103C | T1608 | MARVELIST CARP 10' CARRIER | €28.95 |
| Z20200103B | T2553 | MARVELIST CARP 10' BUTT    | €45.95 |
| Z20200104C | T1608 | MARVELIST CARP 11' CARRIER | €28.95 |
| Z20200104B | T2553 | MARVELIST CARP 11' BUTT    | €45.95 |

**MARVELIST ALLROUNDER ROD SPARES**

| CODE       | TREF  | DESCRIPTION                      | RRP    |
|------------|-------|----------------------------------|--------|
| Z20200109C | T1275 | MARVELIST ALLROUNDER 11' CARRIER | €22.95 |
| Z20200109M | T1719 | MARVELIST ALLROUNDER 11' MIDDLE  | €30.95 |
| Z20200109B | T2553 | MARVELIST ALLROUNDER 11' BUTT    | €45.95 |
| Z20200110C | T1275 | MARVELIST ALLROUNDER 12' CARRIER | €22.95 |
| Z20200110M | T1997 | MARVELIST ALLROUNDER 12' MIDDLE  | €35.95 |
| Z20200110B | T2719 | MARVELIST ALLROUNDER 12' BUTT    | €48.95 |
| Z20200111C | T1442 | MARVELIST ALLROUNDER 13' CARRIER | €25.95 |
| Z20200111M | T2164 | MARVELIST ALLROUNDER 13' MIDDLE  | €38.95 |
| Z20200111B | T2831 | MARVELIST ALLROUNDER 13' BUTT    | €50.95 |

**MARVELIST POWER FEEDER RANGE ROD SPARES**

| CODE       | TREF  | DESCRIPTION                        | RRP    |
|------------|-------|------------------------------------|--------|
| Z20200135C | T2164 | MARVELIST PWR FDR 12' 100G CARRIER | €38.95 |
| Z20200135M | T2219 | MARVELIST PWR FDR 12' 100G MIDDLE  | €39.95 |
| Z20200135B | T2497 | MARVELIST PWR FDR 12' 100G BUTT    | €44.95 |
| Z20200136C | T2219 | MARVELIST PWR FDR 13' 130G CARRIER | €39.95 |
| Z20200136M | T2275 | MARVELIST PWR FDR 13' 130G MIDDLE  | €40.95 |
| Z20200136B | T2608 | MARVELIST PWR FDR 13' 130G BUTT    | €46.95 |

**MARVELIST FLOAT RANGE ROD SPARES**

| CODE       | TREF  | DESCRIPTION                       | RRP    |
|------------|-------|-----------------------------------|--------|
| Z20200132T | T1831 | MARVELIST LIGHT FLOAT 13' TIP     | €32.95 |
| Z20200132M | T2386 | MARVELIST LIGHT FLOAT 13' MIDDLE  | €42.95 |
| Z20200132B | T3053 | MARVELIST LIGHT FLOAT 13' BUTT    | €54.95 |
| Z20200133T | T1942 | MARVELIST MEDIUM FLOAT 13' TIP    | €34.95 |
| Z20200133M | T2497 | MARVELIST MEDIUM FLOAT 13' MIDDLE | €44.95 |
| Z20200133B | T3164 | MARVELIST MEDIUM FLOAT 13' BUTT   | €56.95 |
| Z20200134T | T2164 | MARVELIST MEDIUM FLOAT 14' TIP    | €38.95 |
| Z20200134M | T2719 | MARVELIST MEDIUM FLOAT 14' MIDDLE | €48.95 |
| Z20200134B | T3164 | MARVELIST MEDIUM FLOAT 14' BUTT   | €56.95 |

**IMPAX WHIP POLE SPARES**

| CODE        | TREF | DESCRIPTION           | RRP   |
|-------------|------|-----------------------|-------|
| Z20400002A  | T097 | IMPAX 3M/4M WHIP #A   | €1.75 |
| Z20400002B  | T147 | IMPAX 3M/4M WHIP #B   | €2.65 |
| Z20400002HD | T244 | IMPAX 3M WHIP #HANDLE | €4.40 |
| Z20400003C  | T167 | IMPAX 3M/4M WHIP #C   | €3.00 |
| Z20400003HD | T269 | IMPAX 4M WHIP #HANDLE | €4.85 |

**WHOPPA STOPPA POLE SPARES**

| CODE        | TREF | DESCRIPTION                   | RRP    |
|-------------|------|-------------------------------|--------|
| Z20400003A1 | T442 | WHOPPA STOPPA 6M POWER KIT#A  | €7.95  |
| Z20400003A2 | T275 | WHOPPA STOPPA 6M MATCH KIT #A | €4.95  |
| Z20400003B1 | T275 | WHOPPA STOPPA 6M POWER KIT#B  | €4.95  |
| Z20400003B2 | T331 | WHOPPA STOPPA 6M MATCH KIT #B | €5.95  |
| Z20400003C  | T442 | WHOPPA STOPPA 6M #C           | €7.95  |
| Z20400003D  | T608 | WHOPPA STOPPA 6M #D           | €10.95 |
| Z20400003E  | T886 | WHOPPA STOPPA 6M #E           | €15.95 |
| Z20400003HD | T886 | WHOPPA STOPPA 6M #HANDLE      | €15.95 |



## MARGIN MUNCHER POLE SPARES

| CODE        | TREF  | DESCRIPTION                    | RRP    |
|-------------|-------|--------------------------------|--------|
| Z20400005A  | T497  | MARGIN MUNCHER 45 POLE #A      | €8.95  |
| Z20400005B  | T664  | MARGIN MUNCHER 45 POLE #B      | €11.95 |
| Z20400005C  | T775  | MARGIN MUNCHER 45 POLE #C      | €13.95 |
| Z20400005HD | T1386 | MARGIN MUNCHER 45 POLE #HANDLE | €24.95 |

## WHOPPA STOPPA POLE SPARES

| CODE        | TREF  | DESCRIPTION                | RRP    |
|-------------|-------|----------------------------|--------|
| Z20400007A  | T442  | POWER EDGE CARP 60 #A      | €7.95  |
| Z20400007B  | T1108 | POWER EDGE CARP 60 #B      | €19.95 |
| Z20400007C  | T1664 | POWER EDGE CARP 60 #C      | €29.95 |
| Z20400007D  | T1942 | POWER EDGE CARP 60 #D      | €34.95 |
| Z20400007HD | T2108 | POWER EDGE CARP 60 #HANDLE | €37.95 |

## NTR COMMERCIAL NET HANDLE SPARES

| CODE       | TREF  | DESCRIPTION             | RRP    |
|------------|-------|-------------------------|--------|
| Z20500007T | T997  | NTR COMMERCIAL LNH TOP  | €17.95 |
| Z20500007B | T1386 | NTR COMMERCIAL LNH BUTT | €24.95 |

## IMPAX NET HANDLE SPARES

| CODE       | TREF  | DESCRIPTION                      | RRP    |
|------------|-------|----------------------------------|--------|
| Z20500001T | T831  | IMPAX COMMERCIAL LNH 200 TOP     | €14.95 |
| Z20500001B | T1942 | IMPAX COMMERCIAL LNH 200 BUTT    | €34.95 |
| Z20500002T | T831  | IMPAX COMMERCIAL LNH 300 TOP     | €14.95 |
| Z20500002M | T608  | IMPAX COMMERCIAL LNH 300 MIDDLE  | €10.95 |
| Z20500002B | T1775 | IMPAX COMMERCIAL LNH 300 BUTT    | €31.95 |
| Z20500003T | T831  | IMPAX COMMERCIAL LNH TELE TOP    | €14.95 |
| Z20500003M | T608  | IMPAX COMMERCIAL LNH TELE MIDDLE | €10.95 |
| Z20500003B | T1775 | IMPAX COMMERCIAL LNH TELE BUTT   | €31.95 |

## SOLUS DUO HANDLE SPARES

| CODE       | TREF  | DESCRIPTION                 | RRP    |
|------------|-------|-----------------------------|--------|
| Z20500008T | T997  | SOLUS DUO NET HANDLE TOP    | €17.95 |
| Z20500008M | T1108 | SOLUS DUO NET HANDLE MIDDLE | €19.95 |
| Z20500008B | T1275 | SOLUS DUO NET HANDLE BUTT   | €22.95 |

## SUBLIME SLIMSTICK HANDLE SPARES

| CODE       | TREF  | DESCRIPTION                       | RRP    |
|------------|-------|-----------------------------------|--------|
| Z20500006T | T1386 | SUBLIME SLIM STICK LNH 350 TOP    | €24.95 |
| Z20500006M | T1275 | SUBLIME SLIM STICK LNH 350 MIDDLE | €22.95 |
| Z20500006B | T2775 | SUBLIME SLIM STICK LNH 350 BUTT   | €49.95 |

## IMPAX NET HANDLE SPARES

| CODE        | TREF  | DESCRIPTION                        | RRP    |
|-------------|-------|------------------------------------|--------|
| Z20500004T  | T1386 | SUBLIME CARP MATCH LNH 300 TOP     | €24.95 |
| Z20500004M  | T1053 | SUBLIME CARP MATCH LNH 300 MIDDLE  | €18.95 |
| Z20500004B  | T2219 | SUBLIME CARP MATCH LNH 300 BUTT    | €39.95 |
| Z20500005T  | T1386 | SUBLIME CARP MATCH LNH 400 TOP     | €24.95 |
| Z20500005M1 | T997  | SUBLIME CARP MATCH LNH 400 MIDDLE1 | €17.95 |
| Z20500005M2 | T1108 | SUBLIME CARP MATCH LNH 400 MIDDLE2 | €19.95 |
| Z20500005B  | T2219 | SUBLIME CARP MATCH LNH 400 BUTT    | €39.95 |



Telephone: +44 (0) 1670 798 910 / Email: [sales@nytrofishing.com](mailto:sales@nytrofishing.com) / Web: [www.nytrofishing.com](http://www.nytrofishing.com)

**Sonik Sports Limited, Riverside Business Park, Coniston Court, Blyth, Northumberland, NE24 4RP**

VAT No. 923 6086 24 Company Registration No. 6367388

Sonik Sports Ltd has the right to modify specifications and prices of goods according to the supply position and our on going desire to improve product specifications.

All measurements are approximate. All prices are correct at the time of going to print August 2024.